

Molecular Cloning, Characterization, Expression Analysis and Chromosomal Localization of the Gene Coding for the Porcine α IIb Subunit of the α IIb β 3 Integrin Platelet Receptor^{1,2}

Gloria Estesó, Ángeles Jiménez-Marín, Gema Sanz,
Juan José Garrido and Manuel Barbancho
*Unidad de Genómica y Mejora Animal, Departamento de Genética,
Universidad de Córdoba
Spain*

1. Introduction

Integrins are a long family of heterodimeric transmembrane glycoproteins consisting of multiple combinations of noncovalently linked α and β chains, which generate different complex receptors with different expression patterns and ligand binding profiles. The integrins bind to extracellular matrix (ECM) or to cell-surface ligands, regulating numerous downstream pathways (Hynes, 2002).

Each integrin binds to only a limited series of ligands, ensuring that cell adhesion and migration are precisely regulated. The α subunit mainly determines the substrate specificity with extracellular matrix molecules (ECM) (Yamada, 1991), while the intracytoplasmic tail of the β chain is predominantly responsible for the integrin interaction with the cell cytoskeleton by binding to vinculin, talin and α -actin (Isenberg, 1991). Thus, this heterodimeric association between α and β subunits allows the integrins to act as bidirectional signaling molecules in the different tissues and cell types in which they are widely distributed, mediating a variety of biological processes so diverse as embryogenesis, haemostasis, tissue repair, migration, cell polarity, immune response and metastatic diffusion of tumor cells (Hynes, 1987, 1992; Hemler et al., 1994).

Mammalian integrins have been divided into subfamilies according to their β subunit. The most important β integrin subfamilies are β_1 , β_2 and β_3 . Within a subfamily, the same β subunit can associate with different α subunits. To date, 18 α and 8 β chains -whose combinations provide up to 24 different integrins- have been described in mammal species (Hynes et al., 2002; Alam et al, 2007).

¹The experiments and results showed in this chapter belong to the PhD by G. Estesó directed by J.J. Garrido.

²Sequence data from this article has been deposited with the GenBank Data Libraries under Accession N° JF808665.

The α_{IIb} chain only associates with the β_3 chain providing the $\alpha_{IIb}\beta_3$ (CD41/CD61) integrin receptor which is the most abundant one in platelets. The main role of the $\alpha_{IIb}\beta_3$ receptor is the binding of fibrinogen to the surface of the activated platelet, thereby resulting in the platelet aggregation with significant consequences in the thrombosis and the homeostasis attainment (Clark & Brugge, 1995; Schwartz et al., 1995). Although for a long time it was thought that the α_{IIb} integrin expression was limited to platelets and their precursors (the megakaryocytes), several studies have revealed that the α_{IIb} chains are also expressed in myeloid and in hematopoietic cells (Ody et al., 1999; Corbel and Salaun, 2002). In addition, $\alpha_{IIb}\beta_3$ integrin plays an important role in the progression and invasion of tumors (Chen et al., 1992; 1997) and in the differentiation of cells from the myeloid lineage in bone marrow (Chen et al, 1997; Wall et al, 1997). In humans, both subunits of the $\alpha_{IIb}\beta_3$ integrin show a high level of polymorphism resulting in some cases in clinically important hemorrhagic disorders (Weiss et al., 1996).

Consequently, α_{IIb} has been involved in many, different and important functions related with platelet activation and tumor progression. However, most studies related to α_{IIb} integrin have been carried out in humans, and little is known about the expression of α_{IIb} subunit in porcine tissues and cell types, although pig is generally accepted as an optimal experimental model which is used in different areas as immunology, xenotransplantation, atherosclerosis, cancer or cardiovascular disease because of its similarity to humans (Misdorp, 2003; Lunney, 2007).

In the present study we describe the cloning and molecular characterization of a cDNA encoding the porcine α_{IIb} (CD41) integrin, and the expression pattern of the α_{IIb} mRNAs in a variety of porcine cells and tissues. In parallel, we use immunohistochemistry and flow cytometry to accurately locate the porcine α_{IIb} integrin protein in the same tissues and cell types. For this, we produce a monoclonal antibody against a porcine recombinant α_{IIb} protein. We also study if any change is produced in the level of α_{IIb} transcripts in thrombin stimulated platelets. Additionally, we identify the chromosomal localization of the porcine *CD41* gene.

2. Material and methods

2.1 Tissues and cells

Fresh pig blood from approximately 1 year old healthy pigs was collected at the slaughterhouse into sodium citrate to final concentration of 10% v/v of the anticoagulant. Platelets isolation was carried out according to García et al., 2005. Porcine platelets were pelleted from platelet-rich plasma (PRP) obtained by centrifugation at 200g for 20 min of blood after addition of ACD solution (117mMsodium citrate, 282mMglucose and 78mMcitric acid) to a concentration of 7%v/v. The upper third of the PRP was centrifuged again after addition of prostacyclin (final concentration 2.5 mM) to avoid platelets activation. For platelets activation, the cells were stimulated by the addition of 1 U of thrombin for 3min at 37°C. Porcine tissues were recovered from adult pigs immediately after slaughtering at the local abattoir and frozen in liquid nitrogen until use. Peripheral blood mononuclear cells (PBMC) were isolated from heparinized whole blood using Ficoll-Hypaque (density 1077 g/ml, Sigma) centrifugation at 900 g for 30 min. Mononuclear cells (lymphocytes and monocytes) and granulocytes were collected by aspiration from their respective gradient interphases and washed twice in PBS.

2.2 RNA isolation, RT-PCR and RACE

Total RNA from platelets, cells or tissues was purified according to the *M-MLV Reverse Transcriptase system* (Invitrogen) using the random primers pd(N)₆-5'-PO₃NA⁺Salt (Pharmacia Biotech). RNA samples were kept at -80°C after controlling the quality on a denaturing agarose gel. 5 μ g RNA, resuspended in 9.5 μ l water, were heated for 3 min at 65°C in the presence of random hexamers (7.5 μ M final concentration), and then cooled in ice. RNA was reverse transcribed using 1 μ l Moloney murine leukemia virus reverse transcriptase (200 units/ μ l) (GibcoBRL) for 1 h at 42°C in a final volume of 20 μ l containing 4 μ l of 5X reverse transcriptase buffer, 0.5 μ l ribonuclease inhibitor (50 U/ μ l) (Roche), 1 μ l 20 mM dNTP (Pharmacia) and 2 μ l 0.1 M dithiothreitol. After 10 min at room temperature, 1 h at 42 ° C, and 10 min at 95°C, DEPC H₂O were added until a final volume of 100 μ l. 2 μ l of this mixture were subjected to PCR using 1 μ l *Tth* DNA polymerase (1U/ μ l) (Biotools) and 2.5 μ l each CD41-specific primer (20 μ M) (see Table 1) in a final volume of 50 μ l containing 5 μ l 10x buffer, 2 μ l MgCl₂ (50 mM), and 8 μ l dNTP MIX (1,25 mM each) (Biotools). The amplification consisted in 35 cycles of PCR and each cycle consisted of incubations at 94°C for 1 min, Tm°C for 1 min, and 72°C for 1 min. The amplifications were electrophoresed on 1% agarose/1X TAE gel. RT-PCR on RNA18S cDNA was used as a control. For RACE (Rapid Amplification of cDNA Ends), 1 μ g total RNA from platelet was used to reverse-transcribe using 1 μ l Moloney murine leukemia virus reverse transcriptase (200 units/ μ l) (GibcoBRL) for 1 h at 42°C in a final volume of 20 μ l containing 4 μ l of 10X reverse transcriptase buffer, 1.0 μ l ribonuclease inhibitor (50 U/ μ l) (Roche), 4 μ l 2.5 mM dNTP (Pharmacia) and 2 μ l 3' RACE ADAPTER (20 μ M) in a final volume of 20 μ L. 3' CD41 cDNAs were obtained by PCR using a specific porcine CD41 primer and the anchor primer provided in the kit (Table 1).

2.3 DNA sequencing and sequences analysis

Sequencing was performed using *ABI PRISM BigDye Terminator Cycle Sequencing Ready Reaction Kit* (Applied Biosystems, Foster City, CA, USA) on a thermal DNA cyler GeneAmp PCR System 2400 (Applied Biosystems, Foster City, CA, USA), according to the instructions of the manufacturer, and analysed on an ABI PRISM 3100 Sequencer (Applied Biosystems, Foster City, CA, USA). Porcine CD41 sequence has been deposited at GenBank under number **JF808665**. Sequences were analyzed using the analysis software LaserGene (DNASTar, Londo, UK) and the analysis tools provided by the expasy web site <<http://www.expasy.org>>. Primers design was performed with Oligo 6 (MBI, Cascade, CO, USA) and Amplify 3 (<<http://www.engels.genetics.wisc.edu/amplify/>>). Multiple alignment among CD41 peptide sequences from *Sus scrofa* (GenBank accession no. **JF808665**), *Homo sapiens* (GenBank accession no. **AAI26443**), *Bos taurus* (GenBank accession no. **NP_001014929**), *Mus musculus* (GenBank accession no. **NP_034705**), *Rattus norvegicus* (GenBank accession no. **XP001063315**), *Canis familiaris* (GenBank accession no. **NP_001003163**), *Equus caballus* (GenBank accession no. **NP_001075262**), *Oryctolagus cuniculus* (GenBank accession no. **Q9TUN4**), *Danio rerio* (GenBank accession no. **AAQ82784**) and *Xenopus laevis* (GenBank accession no. **Q5XH72**) was performed by using MUSCLE program (Edgar, 2004).

2.4 Recombinant CD41 protein (rpCD41) expression and purification

DNAs encoding extracellular domains of the porcine CD41 were amplified by PCR. Primers used for amplification contained restriction sites enabling ligation into the expression vector

pET28b (Novagen) following digestion of the PCR product and the vector with *Bam*HI and *Hind*III. Two different pairs of primers were used: F1rp-*Eco*RI/R1r-*pXho*I and F2rp-*Bam*HI/R2rp-*Hind*III (Table1). PCR product was ligated into the expression vector *pET28b* and used to transform *Escherichia coli* strain *BL21 (DE3)* (Novagen). Recombinant proteins (rpCD41-F1R1 and rpCD41-F2R2), expression and purification were carried out following previously procedures described by us (Jiménez-Marín et al., 2000).

2.5 Antibodies production

A monoclonal antibody, GE2B6, against rpCD41-F2R2 and two polyclonal antibodies, anti-rpCD41-F1R1 and anti-rpCD41-F2R2, were produced using previously described immunization and cells fusion procedures (Arce et al., 2002; Jiménez-Marín et al., 2000). Briefly, female BALB/c mice were immunized with 50 µg of rpCD51. Spleen cells from immune mice were fused with Sp2/0 myeloma cells. Hybridoma clones were selected on the basis of binding secreted antibody to rpCD61 by indirect ELISA. Antibody-producing hybridomas reacting positively were cloned at least twice by limiting dilution. Immunoglobulin classes and subclasses were determined in solid-phase ELISA using rabbit antisera specific for mouse heavy and light chains and a peroxidase-conjugated goat anti-rabbit immunoglobulin (Sigma).

2.6 Electrophoresis and immunoblottings

Platelets (10^8 /sample) were lysated in NP-40 lysis buffer with PMSF 2 mM with vigorous shaking for 1 h at 4°C, and then centrifuged at 12,000 rpm, 20 min. 100 µl supernatant were mixed with 100 µl of sample treatment buffer, and 100 µl were loaded in the gel. Electrophoresis was carried out in 5%-15% gradient polyacrilamide gels. For the 2D electrophoresis, the platelet proteins pellet was resuspended in lyses buffer (7 M urea, 2 M thiourea, 4% CHAPS, 1% DTT, 0,8% ampholytes). Immobilized pH gradient strips (17 cm, 5-8 linear pH gradient, Bio-Rad) were rehydrated with 300 µl (300 µg) of the protein solution for 16 h, and focused in a PROTEAN IEFcell (Bio-Rad). Second dimension was performed on 10% SDS-PAGE. For the immunoblottings, proteins were transferred from gels to PVDF Immobilon P membranes (Milipore). Membranes were blocked and washed three times in PBS-T, and then incubated with 3 ml antibody or PBS as negative control, overnight at 4°C in shaking. After three washing ups in PBS-T, the membranes were incubated with rabbit anti-immunoglobulin-peroxidase (Sigma). Afterwards, they were washed up three times in PBS-T, and finally reactions were detected with the ECL™ detection system (Amersham) following the manufactures instructions.

2.7 Immunoprecipitation of platelet CD41 proteins

Platelets (10^8 /sample) were incubated with 0.4 mg sulfobiotin (Pierce) with gently shaking for 15 min at 4°C, and then centrifuged at 3,000 rpm, 15 min. Pellet was washed three times in PBS, and then resuspended in lyses buffer (500 µl/sample) and PMSF 2 mM. After incubation in dark with vigorous shaking for 1 h at 4°C, it was centrifuged at 13,000 rpm, 20 min, and the supernatant was collected. 50 µl of protein G-Sepharose (Pharmacia) were added per ml of supernatant and incubated with shaking overnight at 4°C, and then centrifuged at 2,000 rpm, 5 min. 500 µl lysate were incubated with 1 ml of the anti-porcine CD41 antibody for 2 h at room temperature. At the same time, when monoclonal antibody was going to be used, to increase its binding ability, the G protein is

recovered with an anti-mouse immunoglobulin rabbit serum (Pierce) 1/10 in lyses buffer, for 2 h at room temperature. Then, the G protein is washed three times in lyses buffer, and centrifuged at 2,000 rpm, 2 min. This step was not needed when polyclonal antibodies were used. 50 μ l of the antibody recovered G-Sepharose were added to the lysate containing the anti-CD41 antibody and incubated for 1 h at room temperature with shaking, and then centrifuged at 2,000 rpm, 5 min. The supernatant was collected and washed three times in lyses buffer, the first being in buffer and sucrose. Finally, supernatant was subjected to SDS-PAGE in 5%-15% gels in reducing or not reducing conditions. After electrophoresis, the proteins were transferred to PVDF, Immobilon P membranes, as described before, and, after be blocked, incubated with a solution of Streptavidin-HRP (Amersham) solution 1/500 in PBS for 1 h in dark. Then, membranes were washed three times in PBS-T and revealed with the ECL™ detection system (Amersham) following the manufactures instructions.

2.8 Immunohistochemistry

Expression of CD41 protein from healthy animals was studied following previously procedures described by us (Jiménez-Marín et al., 2008) using monoclonal antibody GE2B6 supernatant or polyclonal antibodies (1/3000 dilution in PBS) or an irrelevant mAb (as negative control). Briefly, all tissue specimens were fixed in Bouin liquid for 16 hours. Tissues were dehydrated in ascending concentrations of ethanol and xylene and embedded in paraffin. Sections of 5 μ m were placed on slides coated with Vectabound (Vector Laboratoires, Inc.). The tissue slides were kept at 55°C for 45 min to improve the adherence of sections to glass. The sections were deparaffinized and rehydrated in xylene and descending concentrations of ethanol, respectively. Endogenous peroxidase activity was inhibited with 3% hydrogen peroxidase. The sections were incubated with normal goat serum (1:10 dilution in PBS) (Vector) for 30 min at room temperature. After removing the serum, anti-porcine CD41 antibodies or an irrelevant mAb (as negative control) were added for 18 hours at 4°C in a wet chamber. The sections were incubated with biotinylated anti-mouse Ig (Dako) diluted 1/50 in PBS for 30 min at room temperature. Tissue sections were covered with avidin-biotin-peroxidase complex (Sigma) diluted 1/50 with PBS for 1 h in a wet chamber at room temperature, washed and then developed with 3, 3'-diaminobenzidine (Sigma) (5 μ g in 10 ml PBS). Sections were counterstained with Mayer hematoxylin and mounted with Eukitt.

2.9 Flow cytometry

100 μ l of platelets (10^6 cells/ml) and 100 μ l of the antibody (or PBS as a control) were incubated 30 min at 4°C. After washing with PBS, tubes were centrifuged at 3,000 rpm, 6 min, and the platelets resuspended in 50 μ l of a rabbit FITC-anti-immunoglobulin (1/160 in PBS) (Sigma). After incubation at 4°C 30 min in dark, the platelets were washed three times in PBS and the fixed in 1% PFA/PBS. Samples were analyzed in a FACsort cytometer (Becton Dickinson) equipped with a CellQuest v 1.2 software.

2.10 Chromosome localization

The INRA somatic cell hybrid panel (Yerle et al., 1996) was screened with porcine primers (VARP1 and VARP2), which specifically amplify a 212 bp fragment (Table 1). For genotyping of the hybrid panel, 10 ng of DNA from each cell line and control sample (pig,

hamster, and mouse) were amplified. PCR products were evaluated on a 1% agarose gel and individual cell lines were evaluated for the presence or absence of a fragment of the correct size. Statistical calculations of the assignment were performed using the software developed by Chevalet et al (1997) (<<http://www.inra.toulouse.fr>>). The INRA-Minesota porcine radiation hybrid (IMpRH) panel (Yerle et al., 1998; Hawken et al., 1999) was screened with the same porcine specific primers in the same PCR conditions (Table 1). Statistical calculations of the assignment were performed using the IMpRH mapping tools (<<http://www.imprh.toulouse.inra.fr>>).

2.11 Quantitative real time RT-PCR

CD41 cDNA was quantified by real time quantitative PCR (RT-Q-PCR) relative to β -actin cDNA reverse transcribed from total RNA from platelets. The PCR reaction was carried out with 0.5 μ l of each VARP1/VARP2 and β -actinF/ β -actinR primers (Table 1) (20 μ M), 12.5 μ l of iQTM SYBR1 Green Supermix (Bio-Rad), and 1.5 μ l of the cDNA sample. The PCR conditions included 40 cycles of 30s at 94°C, 30s at 60°C and 30s at 72°C. All experiments were performed three times to confirm accuracy and reproducibility of real-time PCR. The efficiency of the primers (E) was calculated according to the equation (1).

$$E = 10^{[-1/p]} \quad (1)$$

being p the slope of the standard curve $\log(\text{fluorescence})/\text{Ct}$.

The relative abundance of *CD41* gene expression was determined by the ratio (R) equation (2)

$$R = 2^{[\Delta\text{Ct}(\text{target}) - \Delta\text{Ct}(\text{control})]} \quad (2)$$

being Ct = threshold cycle (cycle at which PCR amplification reaches a significant value).

3. Results

3.1 Cloning and sequence analysis of the porcine *CD41* cDNA

The porcine full length *CD41* cDNA was obtained by a combination of PCR and RACE (Rapid Amplification of cDNA Extremes). A partial sequence that lacked the 3' cDNA extreme, including part of the coding sequence, was deposited in GenBank (**AF170526**). So, we first amplified the pig *CD41* 5' cDNA using forward and reverse primers designed from this sequence. Three pairs of primers were used P3/R4, P1/R2 and F1/R1 (Table1).

Three 1352, 870 and 677 bp long overlapping fragments were produced, respectively. Altogether, the three fragments provided a 2701 bp long sequence that belongs to the 5' extreme of the *CD41* cDNA (Figure1). To obtain the remaining 3' sequence of the *CD41* cDNA we carried out a RACE by using the RACE-out and the RACE-P5 primers shown in Table1. This allowed us to obtain an additional 622 bp long 3' sequence (Figure1). Finally, we obtained the full length *CD41* cDNA molecule amplifying RNA from platelets by RT-PCR by using the FcDNA5 and RcDNA3 pair of primers (Table1 and Figure1) and MBLong polymerase.

Primers	Primer sequences 5'-3'	Template, localization (5'-5')	Product size (bp)	T _m (°C)
FP3	TGTGGAAGAAGGAAGATGG	cDNA, 2-1353	1352	58.1
RP4	GCAGAGCCTGCGGCAAAGG			
FP1	GGGCCAAGTATCGGTGTTC	cDNA, 1264-2133	870	60.0
RP2	TGGGTACAGATGAGCCTCTCTAAG			
F1	CCCCAGGTGCTCACTACA	cDNA, 2066- 2742	677	60.0
R1	TCGGCAGCTCAGGAGAATTGGA			
RACE- <i>adapter</i>	GCGAGCACAGAATTAATACGACTCACT ATAGGT ₁₂	cDNA, 2638-3'	622	60.0
RACE- <i>outer</i>	GCGAGCACAGAATTAATACGACT			
RACE-P5	CTCCCCTGTGTACCCAGCTCATCA			
FcDNA5	CCTAAGCTTAAGATGGCCAGAGCTTTGT GT	cDNA, 13-3125	3113	59.2
RcDNA3	GCAAAGCTTTCCTCCTCTTCATCA GA			
VARP1	GAGGCATGACCTCTTGGTGG	Genomic DNA cDNA, 1012-1223	212	59.0
VARP2	CATTGTAGCCATCCCGGTTC			
F1rp- <i>EcoRI</i>	CGAC <u>GAAAT</u> CCCCCAGGTGCTCACTAC A	cDNA, 2066- 2742	677+20	60.0
R1rp- <i>XhoI</i>	CGAC <u>TCGAGG</u> CAGCTCAGGAGAATTGG A			
F2rp- <i>BamHI</i>	GGT <u>CGATC</u> CTTGAACCTGGACCCAGT GCAT	cDNA, 110-1105	996+20	59.0
R2rp- <i>HindIII</i>	GGT <u>AAGCTT</u> CTGCAGGAACAAGTAAAC ACG			

Table 1. Primers used in PCRs and RACE.

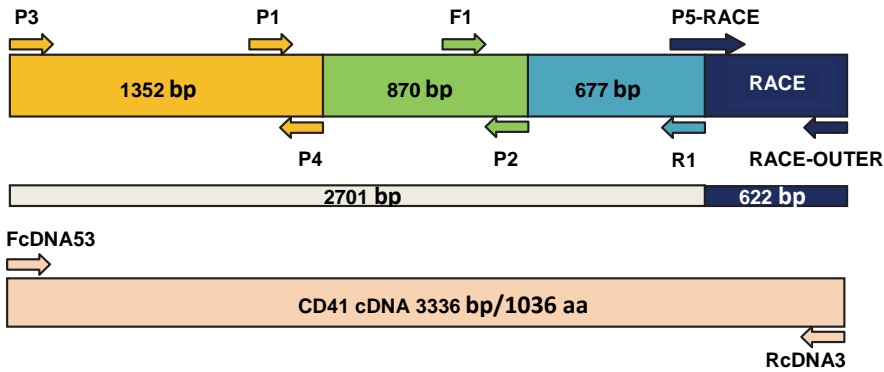

Fig. 1. Strategy and localization of the primers used for cloning the porcine full length *CD41* cDNA.

The full *CD41* cDNA was 3336 bp long and contained an open reading frame of 3111 bp (Figure2) which encodes a CD41 polypeptide of 1036 amino acid residues, and a 198-bp long untranslated 3' flanking region. The nucleotide sequence encoding the full length CD41 pig cDNA was submitted to GenBank (Accession number JF808665).

The first 31 amino acid residues of CD41 are predominantly hydrophobic and correspond to the signal peptide sequence. So, the pig mature pre-CD41 molecule consists of 1005 amino acid residues, and, as this amino acid sequence has a proteolytic cleavage site (KR/D) located between amino acids residues 899 and 900 in pre-CD41 (Takada et al., 1989), the mature porcine CD41 polypeptides -lacking the signal peptide- must be composed by two different chains (914 and 91 amino acid residues) linked by disulfide bridges, similar to those reported in homologous CD41 integrins. Other sequences and structural domains contained in other CD41 proteins are also presents in the porcine CD41 chains (Figure2).

The seven FG-GAP tandem repeats are shown as W with arrows marking their initial and final limits. An α helix is shown in red. The long extracellular domain of the porcine CD41 integrin consists of 869 amino acids residues. It contains 8 consensus N-glycosylation sites (Asn-X-Ser/Thr, where X is not Pro) identified by the NetNGlyc 1.0 program (www.expasy.org), and 18 -from 19- cystein residues. As in other α integrins, the extracellular domain of the porcine CD41 contains four Ca^{++} binding domains (DX(D/N)XDGXXD) and seven FG-GAP tandem repeats -which are identified by the SABLE 2.0 program (<http://sable.cchmc.org/>)- each one containing four helixes similar to those previously described (Springer, 1997; Xiong et al., 2001). The secondary structure of CD41 molecule is shown in Figure3 and the tertiary one, obtained with the Swismodel (www.expasy.org), is shown in Figure4.

The stretch sequence of 26 hydrophobic amino acid residues located in the carboxy-terminal portion of the polypeptide must constitute the transmembrane domain. Following it there is a short 20-amino acid sequence that must represent the cytoplasmic domain of the molecule. It contains a GFFKR (1019-1023 in pre-CD41) domain, which is conserved in all human α integrin chains and is involved in the link of both α and β chains of the heterodimeric complex (Rojiani et al., 1991). It also contains a β -like turn (PPLEE) (1026-1030), that in comparison to the α_v chain (PPREE) could aid in the ligand interaction of fibronectin and

vitronectin with the intact α IIb β 3 heterodimer which is essential for various transductional processes during mammalian organogenesis (Filardo & Cheresch, 1994).

P 3
TTGTGGAAGAAGAAATG CCAGAGCTTTGTGTCTACTTTCATGCCCTTGGCTTCTGGAGTGGGTGCAACTGCTCTTG 79
M A R A L C L L H A L W L L E W V Q L L I 21
F 2
GGACCCGGTGTGCCCTCCAACTTGGCC TTGAACCTGGACCCAGTGCAT CTCACCATTACACAGGCCCAATGGCAGCCACTTTGGG 169
S P G A A P P T W A L N L D P V H L T I Y T G P N G S H F G 51
TTTTCATTGGACTTCTACAAGAAGACCATGGCAGCGTATCCATCGTGGTGGGGCCCCCGGACCTTGGGCCCAACCTGGAGGAGACC 259
F S L D F Y K K S H G S V S I V V G A P R T L G R N L E E T 81
GGCGCGTTTTCTGTGTCCCTGGAAGGCCAAGAGCGTCCAGTGCCTGCGCTGTCCTTCAACCTCGATGATGAGACGCGAAACGTAGGC 349
G G V F L C P W K A K S V Q V A L S F N L D D E T R N V G 111
GCCCAAACCTTCCAAACCTTCAAGGCCCGTCAAGGACTAGGGCGTCCGCTTAACTTGAGAGACAACTGTGGCTTGGCCCCCTGG 439
A Q T F Q T F K A R Q G L G A S V L T W R D N V V A C A P W 141
CAGCACTGGAACGTCAGAAAGAAGCAGGAGGCTGAGAAGACACCTGTAGTGGTGCCTTCGTGGCTCAGCTCCAGAACAGCGGCCG 529
Q H W N V L E K N E E A E K T P V G G F V A Q L Q N S G R 171
GCGGAGTTCTCGCCCTGTCGGGCCAACCTCTTGAGCCTGGTTACGTGGAAGTAAATTCATGACAGGCCCTATTGGCAGGTCCGCTTC 619
A E F S P R A N L L S L V Y V E S K F N D R R Y E V G F 201
AGCTTCGCGGTCACTCAGCTGGGAGCTGGTGTCTGGGGCTCTGGGGCTACTATTCTTAACTCATGGCAGCGGCTCCAATGGC 709
S S A V T Q A G E L V L G A P G G Y Y F L S L M A R A P I A 231
GATATCATCTGAGTTACGCCAGGACCCCTCTGTGGCAGTGCACCACAGAGCTCACCTTCGSDCTTCTGAGTACTAC 799
T I I S S Y R P T L L W H V P T Q K L T F D S A D L F P E Y Y 261
GAGAGCTACTTGGGGTACTCGGTGGCTTGGGGAGTTCGACCGGAATCCCAACACCACAGAGTACATCCTCGTGGCCCCACCTGGAGC 889
E S Y L G Y S V A V G E F P D R N P N T T E Y I L G G P T W S 291
ATGACCCGGGAGCGTGGAAATTTTACCTCGAAACACCAGAGGCTGCACCTGCTCAGGGAGAGCAGGTGGCTCATATTTCCGGGCAT 979
M T L G A V E I F T S K H Q R L H L L L Q G E Q V A S Y F G H 321
TCAGTGGCCGTCACCGAGCTCAACGGGGACGGGAGCATGACCTTGTGGTGGAGCCCACTGTACATGGAGCCGCTGCTGACCAACAAG 1069
S V A V T E V N G D G R H D L L V G A P L Y M E S R A D H K 351
R 2
CTGGCCGAGTGGGG CGGTTTACTTGTTCCTGCAGT CTCGAGGTCACCACTCGTGGGCACCCCGCCTCTGCTGACAGGCACACAG 1159
L A E V G R V Y L F L Q S R G H H S L G T F S G L L L L T G T G T Q 381
CTCTATGACGATTTGGCTCAGCCTCGGCCCTTGGGCGACTTGAACCCGGATGGCTACAATGATGTTGCCGTGGCCGCCCTTATGG 1249
L Y G R F G S A I A P L E L N R D G I N D V A A A P Y G 411
GGTCCACCGTCA GGCCAAAGTATCGGGTTC CTGGTTCAGAGTGAGGGGCTTAACTCGCAGCCCTCCAGGTCTCGCAGCCAGTTC 1339
G P T G Q G Q V S V F L G Q S E G L N S Q P S Q V L H S P F 441
P 4
GCCGACGGCTCTGGCTTTGGCTTCTCCCTTCAGGTGCCACAGACATCGATGACAATGGATACCCAGACCTGCTGGTAGGAGCTTACGGG 1429
A A G S A F G F S L R G A T E I D D N Q Y F D L L V G A Y G 471
GCCGACAAGTGTCTGTACCGAGCTCAGCCGGTGTGACCCCACTGTCCAGCTGATGGTGAAGAATCCCTGAATCCTGTGTGAAG 1519
A D K V V V Y R A Q P V V T A T V Q L M V Q E S L N P A V K 501
AATGTGTCCAGCCCAACCAAGACACCACTGAGCTGCTTTACCATCCAGATGTGTGGGAGCCACTGGGCACAACATCTTCGAGAAG 1609
N C V Q P Q T K T P V S C F T I Q M C V G A T S G H N I P E K 531
CTGCGCTAAATGCCGAGTGCAGCTGGACCGCAGAAACCCACACAGACCGGGGGTGTCTGTCTGGCTTCCCAACAGCGGAGCACT 1699
L R L N A E L Q L D R Q K P H Q S R R V L L L L A S Q Q A S T 561
GTCTGGACGTGGATCTGACCTGGAGGCAGGCCACCTGCCCAACACCACCGCCCTTCTCCGGGATGAGGCTGATTTCCGGGACAAG 1789
V L D V D L T W R Q S P T C H N T T A F L R D E A D F R D K 591
CTGAGCCCATCGTGTCTAGTCTCAATGTGTCCCTGCAGCCGGAGAAGAATGGAGACGCCCTCACGTTTCATGCTGCATGGAGACCCAC 1879
L S P I V L S F L V S L Q P E K N G D A L T F M L H G D T H 621
GTTCAGAACAGACCCGCATCATCTGGACTGTGGGGAAGCAAGTGTGCGTGCCAAAGCTCCAGCTCTCGGCCAACACGACCGCTCC 1969
V Q E Q T L R I I L D C G E D Q V C V P K L G A T S G N T T G S 651
CCACTCTAGTTGGAGCTGATAATGTGTGGAGCTGCACGTGTTCGGCCCAATGAGGGCGAGGAGCCCATGAGGCCGAGCTGGTTGTG 2059
F L L V G A D N V L E L H V V A A N E G E G A H E A E L V V 681
CACCTG CCCCAGTCTCTACTA TGCAGGCCCTCAGCAACCAAGAGCTT TCGAGAGGCTCATCTGATCGG GAAGAAGGAGATGAG 2149
H L P P G A H Y M Q A L S N T K S F E R L I C T Q K K E N E 711
ACCAAAGTGGTGTGTGAGCTGGGCAACCCATGAAGGGGACACCCAGATAGAAATCAGATGTTGGTGTGTTGGGGAACCTGGAA 2239
T K V V L E L G N P M K G D T Q I E I T M L V S V G N L E 741
GAGGCTGGGAGCAGCTGTCTCCGGTTCAGATCAGGAGCAGAAACAGCCAGAATCCAAACAGCAGACAGTGGTGTGGATGGTGC 2329
E A G E H V S F R L Q I R S K N S Q N P N S E T V V L D V Q 771

```

GTCGGGCAGAGGCCACCTGGAGCTGAGAGGGAACCTCTTCCAGCCTCCCTGTTGATGGCCGAGAAAGCGATTGGGAGAACAGCTCG 2419
V R A E A H L E L R G N S F P A S L L M A A E G D W E E S S 801

GACAATTGGGCCCAAGTGGAGCACACCTATGAGCTCCACAACAATGGCCCTAGTACCGTAAGTGGCCTCCACCTCAGGCTCCACCTG 2509
D N L G P K V E H T Y E L H N N G P S T V S G L H L R L H L 831

CCCGGCCAGTCCAGACCTCCGACCTGCTCTACATCGTGGACATACAGACCCAGGAGGCCTTCAGTGTCCCCGCGAGCCCTCTCCCAAC 2599
P G Q S Q T S D L L Y I V D I Q T Q G G L Q C S P Q P S P N 861

CCCCGCCAGTGGACTGGGGGTGCACAGCCCCACACCCTCCCTGTGTACCCAGCTCATCACAAGCGAATCGCAGACAGGCAGTCTCTG 2689
P R Q L D W G L H S P T P S P V Y P A H H K R N R R Q A V L 891

CCAGGGCAGAAGCAGCCGTTGAGTCTTCAGGATTCCAATTCTCTGAGCTGCGACTCGGGCCCTGCACCGTGGTGCACCTGTGACCTCCG 2779
P G Q K Q P L S L Q D P I L L S C D S A P C T V V H C D L P 921
▲

GAGATGGCGCGTGGGCAGCGGGCCATGGTCACCGCGCAGGCTTCTCTGGCTGCCAGCCTCCGCGCAGAGACCCCTGGATCAGTTTGTG 2869
E M A R G Q R A M V T A Q A F L W L P S L R Q R P L D Q F V 951

CTGCGGTGCGACGCTTGGTCAACGTCTCTCCCTCCCTACGCCGTGCCCGCCCTCAGCCTGCCAGCGGGGAAGCTCAGGTGCAGACA 2959
L R S H A W F E V S S L P Y A V P A L S L P S G E A Q V Q T 981

CAGGTGCTTCGGGTCTTGGAGGACAGAGGTTCCACTCTGGTGGATGCTGGTAGGCGTGTGGGGCCCTGCTGTTGCTCACACTGTGCT 3049
Q V L R V L E D R E V P L W W M L V G V L G G L L L L T L L 1011

GTCCTGGCCATGTGGAAGTGTGGCTTCTCAAGCGGAATCGGCCACCCCTGGAAGAATCTGATGAAGAGGAGAGTGACGTGCAGCCCA 3139
V L A M N K C G F F K R N R P P L E E S D E E E * 1036
CACATCTGTTCCTGCAGAAAGGCTGCATGGTGTGACTGCCCTGCTCCCTCTCTCCAGCCAGTGCCTCGGAGCTCTGCTCGGCCATGA 3229
ATTGGAGCTGTTCCCTGGAGGCCTCCCGATGCTCCTGCTCCCATCAGAGCTGGCTCACCCCTTCTGCTGCCTAATAAAGAGGCTG 3319
AACCCCAAAAAAAAAA 3336

```

Fig. 2. The nucleotide and deduced amino acid sequences of pig *CD41* cDNA. The predicted signal peptide is remarked in light green, the transmembrane domain in dark green, and the cytoplasmic region, containing the GFFKR sequence, in purple. The putative polyadenylation sequence is remarked in a black box. Potential N-glycosylation sites are indicated in red. Cysteine residues are marked as C in yellow. Putative cleavage sites are shown as ▲. Ca⁺⁺ binding domains are remarked in pink. Primers used for cloning are marked with arrowheads.

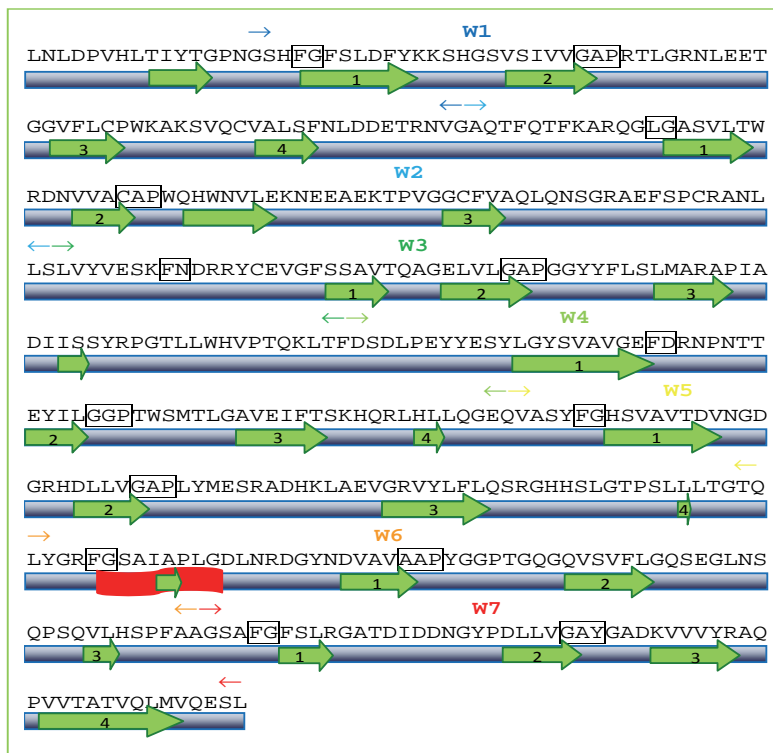

Fig. 3. Secondary structure of the porcine CD41 molecule. Sequences in β antiparallel sheets are shown in green.

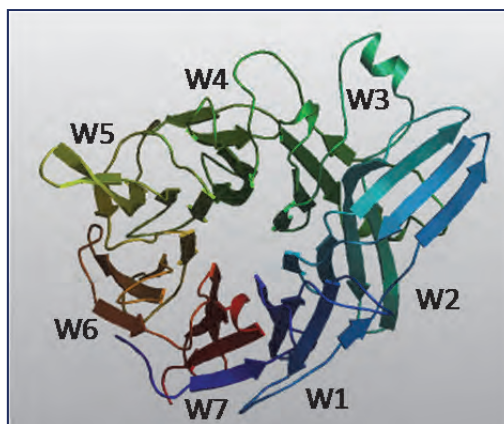

Fig. 4. Three-dimensional structure of the porcine CD41 molecule. The seven FG-GAP tandem repeats are shown as W, each one composed by four β antiparallel chains.

3.2 Comparative analysis

The deduced protein sequence of the porcine CD41 was compared to their orthologous proteins from six different species: humans, cattle, horses, dogs, rats, rabbits, mice, zebrafish and xenopus (Figure5 and Table2).

PIG	MARALCLLHALWLEWVQLLGPGAAPPTWALNLDVPHLTIYTGPN	60
HUMAN	MARALCPLQALWLEWVLLLLGPCAAPPAAWALNLDVPQLTFYAGPN	60
HORSE	MARALRPLHALWLEWMLLGLPGTAPQAWALNLDVRLTFYTGPN	60
RABBIT	MARALGPLPAFWLEWALLLLGPGAGPPAAWALNLDVPQLTIYTGPN	60
DOG	MARAVCPNALWLEWVQLFLGPGAIPLGWAALNLDVPQLTFYTGPN	60
COW	-----PTWALNLDVQFTVYTGPN	60
RAT	MARASCAWNTLWLLQWTPFLGPSAAPPAAWALNLDVPKFSVYTGPN	33
MOUSE	MARASCAWHSWLLQWTPFLGPSAVPPVWALNLDSEKFSVYAGPN	60
ZEBRA FISH	----MDKKLEFSLFLSILIFT----NHIRGFNLDLNQYTVFSGPEDSYFGFSVDFYQSS	52
XENOPUS	-----MVPWLLLLLP----AFIQNLNLDK-KPQTLSPGPGSHFGFSMDFYNTA	43
PIG	HGSVSIIVVGAPRTLQ--RNLEETGGVFLCPWKAKSVQCVALSFNLD-DETRNVGAQTFQT	117
HUMAN	HGRVAIVVGAPRTLQ--PSQEETGGVFLCPWRAEGGQCPSSLFDDL-DETRNVGSQTLQT	117
HORSE	RGSVSIIVVGAPRTLQ--RSQEEMGGAFVCPWKAEGGQCTSLSFDDL-DETRNTSSQIFQT	117
RABBIT	HGSVAIVVGAPRTLQ--LGQKETGGVFLCPWKAEGSPCSLLSFNLS-DEYRKTSSQLFQT	117
PERRO	HGRVAFVVGAPRTLQ--RSQEETGGVFLCPWRAEGGQCTSLSPFDLN-DETRHIGSHTFQT	117
COW	NGSVYVVVGAPRTLQ--HSEETGGVFLCPWKAEGGQCTSLSPFDLY-DETRISIGTQTFQT	090
RAT	HGSVSIIVVGAPRALN--ANQEETGGVFLCPWKANNCTCSLLFDDL-DETRKLSFQTFQT	117
MOUSE	HGSVSIIVVGAPRALN--ASQEETGAVFLCPWKANGGKCNPLFDDL-DETRNLGFQIFQT	117
ZEBRA FISH	SKSVSVVVGAPRANTNQSGVSHGGSVFMCPWATRQGCQTLNFDQKGDENITFGNMLLMA	112
XENOPUS	DQGMSIIVVGAPRMQTSQRNVTMGGVFLCPWPKKGSVCVNKIFDSTGDRSIPFAGYTMKI	103
PIG	FKARQGLGASVLTWRDNVVA	176
HUMAN	FKARQGLGASVVSWSVDVIVA	176
HORSE	FKAQOGLGASVVSWSDYVVA	176
RABBIT	FRARQGLGASVVSWNDIIVA	176
DOG	FKSRQGLGASVVSWNNDIVA	176
COW	FKAGQGLGASVVSWRDSIVA	150
RAT	FKTGQGLGASVLSWNDVIVA	176
MOUSE	FKTGQGLGASVVSWNVDVIVA	176
ZEBRA FISH	HKSNQWLGAASVRYNNYILACAPLPHWNVLVDQEE-AMNTPVGN	171
XENOPUS	FKSNQWFGAIVRTWNTAIVA	161
PIG	CRANLLSLVYVESKFND-RRYCEVGFSSAVTQAGELVVLGAPGGYFVFLSLMARAPIADIIS	235
HUMAN	CRGNTLSRIYVENDFSWDKRYCEAGFSSVVTQAGELVVLGAPGGYFVFLGLLAQAPVADIFS	236
HORSE	CRDNIMSHVYSKTYLGD-KRYCEAGFSSAVTQAGELVVLGAPGGYFVFLGLLARAPIANIIS	235
RABBIT	CRGNTMSHVYEKMYLRD-LRSC	235
DOG	CRANTMSSVYVKNRFRNQDKRYCEAGFSAAVTQAGVVLGAPGGYFVFLGLLVRTPIDNIIS	236
COW	CRDNKMSQFYERNHFRDDRRYCEAGFSSVVTXAGELVVLGAPGGYFVFLGLLARAPIADIIS	235
RAT	CRNTMSSVYSQGFSGD-KRYCEAGFSLAVTQAGELVVLGAPGGYFVFLGLLVRTPIDNIIS	210
MOUSE	CRANTMSSVYAESFRGD-KRYCEAGFSLAVTQAGELVVLGAPGGYFVFLGLLARAPIANIIS	235
ZEBRA FISH	CREEYVYAIYTRG--YPDRRYCEAGFTTDITKNRVLVLAGPGGYFVFLGLLARAPIANIIS	229
XENOPUS	CRESKMERLHYEA-----DRRFCELGFSTDINKDGTLLLAGAPWG-YFQGLYVTAAGLPNIIA	215
PIG	SYRPGTLLWHVPTQKLTFDSDLPEYYESYLGYSVAVGEFDRNPNTTEYILGGFTWSMTLG	295
HUMAN	SYRPGILLWHVSSQSLSPDSSNPEYFDGYWGYSAVGEFDDGLNTEYIYVVGAPTWSWTLG	296
HORSE	SYRPGTLLWSVPTQRFTFDMSKPEYFDGYRGYSVAVGEFDEDLSTTEYVYVFGAETWSWTLG	295
RABBIT	SYSPGVLLWTVPNQNFYDYSNRKYPFDGYRGYSVAVGEFDDGLSTTEYVYVFGAETWSWTLG	295
DOG	SYRPGTLLWHVSSQSFYDYDYSKPEYFDGYRGYSVAVGEFDDGLNTEYIYVVGAPTWSWTLG	296
COW	SYRPGTLLWHVPTQ-FTYDQSHLQYDGYRGYSVAVGDFDGNPNTTEYVYVFGAETWSWTLG	269
RAT	TYRPGTLLWHVSNQRFYSYDSSNPVYFHYRGYSVAVGEFDDGLSTTEYIFGAPTWSWTLG	295
MOUSE	TYRPGTLLWHVSNQRFYDSSNPVYFHYRGYSVAVGEFDDGDPSTTEYVYVVGAPTWSWTLG	295
ZEBRA FISH	SGSSFTPKHSMNGETKTPQRRD--YYDLVLYGYSVAVGAKFNND-NIPDYVYVGNLHTAG	286
XENOPUS	RPASSLLQSYPGQIQISPYIGS--SFDYSYKGFSAVYGEFTGD-NTPYIIVVGS-KEYDRG	271

PIG	AVEIFT---SKHQLHLLQGEQVASYFGHSAVAVTDVNGDGRHDLVVGAPLYMESRADHKL	352
HUMAN	AVEILD---SYQRLHRLRAEQMASYFGHSAVAVTDVNGDGRHDLVVGAPLYMESRADRKL	353
HORSE	AVEILD---SNFQMLHRLHGEQMASYFGHSAVAVTDVNGDRRHDLVVGAPLYMERRADRKL	352
RABBIT	AVEILD---SYFRLHRLQGEQMASYFGHSAVAVTDVNGDGRHDLVVGAPLFMASQADHKL	352
DOG	AVEILN---EYHQLHRLHGEQMASYFGHSAVAVTDVNGDGRHDLVVGAPLFMESRADRKL	353
COW	AVEILD---SYHQLHRLHGEQMASYFGHSAVAVTDVNGDGRHDLVVGAPLYMESRADRKL	326
RAT	AVEILD---SYYQLHRLHGEQMASYFGHSAVAVTDVNGDGRHDLVVGAPLYMESRVDRKL	352
MOUSE	AVEILD---SYYQPLHRLHGEQMASYFGHSAVAVTDVNGDGRHDLVVGAPLYMESRADRKL	352
ZEBRA FISH	SVKIINGATVPLQIMKAIISGTQIASYFGHSAVAVTDINRDGWDILIGAPLFMEQLSTQKF	346
XENOPUS	LVDIYT-VSNPWKTFISFLGKQVASYFGHSAVAVTDVNNDRDVLVVGAPLFMERTRGKL	330
PIG	AEVGRVYLFLOSRGHHSGLTTPSLLLTTGTQLYGRFGSAIAPLGLDNRDGYNDVAVAAPYGG	412
HUMAN	AEVGRVYLFQPRGPHALGAPSLLLTTGTQLYGRFGSAIAPLGLDNRDGYNDIAVAAPYGG	413
HORSE	AEVGRVYLFQPRSPQPLGPASLLLTTGTQLYGRFGSAIAPLGLDNRDGYNDVAVAAPYGG	412
RABBIT	AEVGRVYLFLOLQPPHLLGAPSLLLTTGTQLYGRFGSAIAPLGLDNRDGYNDVAVAAPYGG	412
DOG	AEVGRVYLFQPRGHQALGAPSLLLTTGTQLYGRFGSAIAPLGLDNRDGYNDVAVAAPYGG	413
COW	AEVGRVYLFQTRGARMGLGAPNLLLTTGTQLYGRFGSAIAPLGLDNRDGYNDVAVAAPCGG	386
RAT	AEVGRVYLFLOPKGLQALSSPTLVLTGTQVYGRFGSAIAPLGLDNRDGYNDVAVAAPYGG	412
MOUSE	AEVGRVYLFLOPKGPQALSTPTLLLTTGTQLYGRFGSAIAPLGLDNRDGYNDIAVAAPYGG	412
ZEBRA FISH	REVGQVYVYLQRNDFSFASRPNIQLAGTYAGRFGSAIAPLGLDHDGFDNDVAVGAP--G	404
XENOPUS	QEFQVYVYVYLQRNDRKFSFN-HPVLTGSGVYGRFGSSIAPLGLDIDQDGFNDVAVGAPFPG	389
PIG	PTGQQGVSVFLGQSEGLNSQPSOVLHSPFA---AGSAFGFSLRGATDIDDNGYPDLLVGA	469
HUMAN	PSGRQVLYVFLGQSEGLRSRPSQVLDSPFP---TGSAGFGSLRGAVDIDDNGYPDLLVGA	470
HORSE	PDGRGQVLYVFLGQSEGLSSHPSQVLDSPFS---TGSAGFGSLRGATDIDDNGYPDLLVGA	469
RABBIT	PSGRQVLYVFLGQSEGLNPHSPQVLDSPFP---AGSAFGFCLRGATDIDDNGYPDLLVGA	469
DOG	PSSLGQVLYVFLGQSEGLSRPSQVLDSPFP---AGSGFGFSLRGATDIDDNGYPDLLVGA	470
COW	PNQGGQVLYVFLGQSEGLNPSPSQVLDSPFP---TGSAGFGSLRGATDIDDNGYPDLLVGA	443
RAT	PSGQQQVLI FLGQSEGLSPRPSQVLDSPFP---TGSAGFGSLRGSVDIDDNGYPDLLVGA	469
MOUSE	PSQQGQVLI FLGQSEGLSPRPSQVLDSPFP---TGSAGFGSLRGAVDIDDNGYPDLLVGA	469
ZEBRA FISH	SVDGKVFYIYLGKSGGLSTQYVQVIESPFRSLIDPPMFGFSIRGGTIDDNGYPDLIIIGA	464
XENOPUS	ESGGGCVFIYRGSAPGLSPQPSQILESPLP---PPAQGFALRGGMDIDDNGYPDLLVGA	446
PIG	YGADKVVVYRAQPVVTATVQLMVQ-ESLNPVAVKNCVLPQTKTPVSCFTIQMCGVATGHNI	528
HUMAN	YGANQVAVYRAQPVVKASVQLLVQ-DSLNPVAVKNCVLPQTKTPVSCFNIQMCVATGHNI	529
HORSE	YGANKVAVYRAQPVVMVSVQLLVN-DSLNPVAVKNCVLPQKTKSVSCFDIQMCGVATGHNI	528
RABBIT	YGADKVVVYRAQPVVMADVQLLVQ-DSLNPVAVKNCVHLQNTTPVSCFNIQMCVATGHNI	528
DOG	YGASKVAVYRAQPVVANVQLLVQ-DSLNPVAVKNCILPQTKTPVSCFNIQMCVATGHNI	529
COW	YGASKVVVYRAQPVVMVTVQLMVQ-DSLNPVAVKNCVLSQTKTPVSCFNIQMCVATGHNI	502
RAT	YGASKVAVYRAQPVVMATVQLMVQ-DSLNPVAVKNCVLEQTKTPVSCFNQMCVATGHNI	528
MOUSE	YWASKVAVYRAQPGVMATVQLMVQ-DSLNPVAVKNCVLDQTKTPVSCFNIQMCVATGHNI	528
ZEBRA FISH	WGASKVVYRAQAVVTRQARLSFFPDLLNPEDKFCQLQSQSGTYITCFTTMACIRVSGHRI	524
XENOPUS	FHADKVFIFRTQPVVVLQASLFFNPEALNPEKLCNFPQSGPAVSCFTIRVCAQASGRSL	506
PIG	PEKLRNLNAELQLDRQKPRQGRVVLLLSQAGTTLNLDLGGKHSPICHTTMAFLRDEADF	588
HUMAN	PQKLSLNAELQLDRQKPRQGRVVLLLSQAGTTLNLDLGGKHSPICHTTMAFLRDEADF	589
HORSE	PEKLRNLNAELQLDRQKPRQGRVVLLLSQAGTTLHLDLGGRTSPNCRITIEAFLRDEADF	588
RABBIT	PQGLYLQAEQLDRQKPRQGRVVLLLSQAGTTLNLDLGGRTSPNCRITIEAFLRDEADF	588
DOG	PQKLSLNAELQLDRQKPRQGRVVLLLSQAGTTLHLDLGGRHSPICHTTMAFLRDEADF	589
COW	PEKLRNLNAELQLDRQKPRQGRVVLLLSQAGTILNLDLGRHNPNCSTATAFLRDEADF	562
RAT	PQKLHLKAEQLDLQKPRQARRVLLLSRQASLTLSDLDGGRNKPICHTIKAFRDEADF	588
MOUSE	PQKLHLKAEQLDLQKPRQGRVVLLLSQAGTTLSDLDGGRDKPICHTTGAFRDEADF	588
ZEBRA FISH	PQQIVFNTLQLDRMKQSMARRTLLLSNQPYTNFQISVDRNSRDVCRNFTAYLLP--EF	582
XENOPUS	PKKISLSAELQLDRKSRFARRTFLLDSSQPSKTIIDMEIQSNAQICQNLTPYLRGESEF	566
PIG	RDKLSPIVLSFNVSLSLQPEKNGDALTFMLHGDTHVQEQTRIILDCGEDDQVCPVQLQLSANT	648
HUMAN	RDKLSPIVLSLNVSLPPEAGMAPAVVHLHGDTHVQEQTRIIVLDSGEDDVCVPQLQLTASV	649
HORSE	RDKLSPIVLSLNVSLQPEKDGIAPALVHLHGDTHVQEQTRIILDCGEDDLCVPQLHLTANV	648
RABBIT	RDKLSPIVLSFNVSLSLQPEAGVAVAVVHLHGNTHVQEQTRIILECGEDDVCVPQLHLTASL	648
DOG	RDKLSPIVLSLNVSLQPRKDGVAVAVVHLHGDTHVQEQTRIILDCGEDDLCVPQLQLTAVI	649
COW	RDKLSPIVLSFVSLSLPEKDGAPALVHLHGNTHVQEQ-----	599
RAT	RDKLSPIVLSLNVSLPPEETGVAVAVVHLHGVTHVQEQTRIILDCGEDNLCVPQLQLTATA	648
MOUSE	RDKLSPIVLSLNVSLPPEETGGAPAVVHLHGHVTHVQEQTRIILDCGEDDLCVPQLRLTATA	648
ZEBRA FISH	KDKLSPIFISVNYSLADSQ----NAVHLHGQSVAVGQTRIILNCGEDDVCIPDLQKAVT	637
XENOPUS	KDKLSPIAMSVNFSLVRAQSMDTVQPTLHGTTFLQEQTNILLDCGDDNVCIPNHLHTANW	626

PIG	TGSPLLVGDADVLELHVVAANEGEGAEELVHLLPPGAHYMQALSNTKSFERLIC	708
HUMAN	TGSPLLVGDADVLELQMDAANEGEGAYEAEAVHLLPQGAHYMRALSNVEGFERLIC	709
HORSE	TGSPLLIGADVNLKQMDATNEGEGAYEAEAVQLPPGAHYMQALSNIIEGFERLIC	708
RABBIT	KGSPLLIGADVNLQMVANDGEGAYEAEVHLLPLGAHYMRAVSTMEGLERLIC	708
DOG	MGSPLLIGADVNLQMDAANEGEGAYEAEAVHLLPPGAHYMRAISNIEGFERLIC	709
COW	-----GFERLIC	610
RAT	GDSPLLIGADVNLKLVNASNDGEGAYEAEAVHLLPPGAHYIRAFSNVKGFERLVCTQ	708
MOUSE	GDSPLLIGADVNLKLEIAANDGEGAYEAEAVHLLPPGAHYMRALSNIEGFERLVCT	708
ZEBRA FISH	STEPILIGDENPALLIEAENQEGEGAYETELYISSPANTHYQGVLSNHEDFSALV	697
XENOPUS	SADPLLIGIDNLVHVQFNAAANLGGEGAYEAEVWLPNGAHYMQVLG--EAEKIL	684
PIG	ENETKVVLC	768
HUMAN	ENETRVLVCELGNPMKKNQAIGIAMLVSVGNLEEAGESVSFQLQIRSKNSQNPNSK	769
HORSE	ENETKVVLC	768
RABBIT	ENQTKAVLCELGNPMK-QARIGITMLVSVGNLEEDAGESVSFQLQIRSKNSQNP	767
DOG	ENETKVVLC	769
COW	ENETKVVLC	670
RAT	ENESRLALCELGNPMKDDTRIGITMLVSVIEEAGDSVSFQLQIRSKNSQNPNS	768
MOUSE	ENESRVLCELGNPMKDDTRIGITMLVSVENLEEAGESVSFQLQVRSKNSQNPNS	768
ZEBRA FISH	ENGSVIVVCDLGNPLEAGQQLKAGLYFSMGDLEQVENHITFQMQIRSKNSQNS	757
XENOPUS	GNSEIVVCELGNPMKNGAEIHADLQLSFSNLEDSGSTVTFQMQIKSRNTVNS	744
PIG	DVQVRAEAHLELRGNSFPASLLMAA-EGDWE--N	824
HUMAN	DVVPVRAEAQVELRGNSFPASLVVAEEEGEREQ--N	827
HORSE	HVPVRAEARVELRGNSLPASLVVAEEEDDRK--N	825
RABBIT	AVPVRAAAQVELRGNSFPASLVLAEEGDQEQ--N	821
DOG	DVVPVRAEAHVKLRGNSFPASLVVAEEDNRE--N	826
COW	DVVPVRAHVHVELRGNSFPASLVVAEEEGNGQ--N	727
RAT	PVAVRAEAAVELRGNSFPASLVVAEEVDKEQ--D	826
MOUSE	PVAIQAEATVELRGNSFPASLVVAEEEGDREQ--E	826
ZEBRA FISH	QVMVTVASLEMRGVSSPVDCVLPISKWESKDYPEDLDEVGLPIEHVYELRN	816
XENOPUS	TMAVKVTASLELRGSSHPAEVILPLPNWEPREERWKAQDYGEEVTHVYELHNS	803
PIG	LHLRHLHLP	882
HUMAN	LHLSIHLPG-QSQPSDLLYILDIQPGGLQ	884
HORSE	LRLSLHLPS-QSQPSDLLYILDIQPGGLQ	882
RABBIT	LHLLIHLPG-QSQPSDLLYILGIEPQGGGLQ	882
DOG	LHLHLCPFG-ESQPSDLLYILDIQPGGLQ	883
COW	LRLNLYLPS-QSQPSDLLYILDIDHPQGGGLQ	883
RAT	LSLI IHLPG-QSQPSDLLYILDVQPKGGGLQ	883
MOUSE	LRLLIHHPG-QSQPSDLLYILDVQPKGGGLQ	880
ZEBRA FISH	VKLTLEFPV-SQNESYLLVVFANASEELIS	871
XENOPUS	VQLLLQSP-E-MYHGDYFLYPLRLLEVDDGMTCD	862
PIG	HKRDRRQIFL-----PEPEQPSRLQDPVLVSCD-SAP	927
HUMAN	HKRDRRQIFL-----PEPEQPSRLQDPVLVSCD-SAP	929
HORSE	HQRERREAF-----PGPMQPSRLQDPVLVSCD-SAP	927
RABBIT	RRERRHADLLE-----PQPSAAGPRDPVLVSCD-SAP	924
DOG	HKRERRQASL-----PGSQPSRLQDPVLVSCD-SAP	928
COW	HKRDRRQAVL-----PEEKQPSRLQDPVLVSCD-SAP	826
RAT	HDRDRREASP-----QGSQTEQDPVLVSCD-SAP	928
MOUSE	HQRERRQAF-----QGPK-PGQDPVLVSCD-SAP	924
ZEBRA FISH	HHFNKRDL-----QKTENEQQWQHTVHVNS	916
XENOPUS	HLRERDLRRWGADEGMQEDGVNITKDEKPPRNHTVLLN	921
PIG	QRAMVTAQAFWLPLSLRQRPLDQFVLRSHAWFN	987
HUMAN	QRAMVTVAFLWLPLSLRQRPLDQFVLRSHAWFN	989
HORSE	QRAMVTVRAFVWLPLSLRQKLLDQFVLRQRAWFN	987
RABBIT	QRAMVTVALLGLSSLRERPLDQFVLRQRAWFN	984
DOG	QRAMVTVLAFVWLPLSLRQRPLDQFVLRQRAWFN	988
COW	QRVMVTVALLLSRSILQERPLDQFVLRQRAWFN	886
RAT	QRAMVTVQATLGLSILRQRPEQFVLRQRAWFN	988
MOUSE	QRAMVTVQAMLGLSSLRQRPEQFVLRQRAWFN	984
ZEBRA FISH	ERAIVRVMRSLVQVTFLLKRPYVNYVHLHSTAHYEVMMVPSKIQDPDLPTGKA	976
XENOPUS	GRATVKLHSLILWVPSFLKRQQQFVLLSQGSFVWTVSVPYKIQPVALVYGNAT	981



Fig. 5. Comparison of the porcine CD41 amino acid sequence to other homologous molecules. The sequences were derived from GenBank entries with accession numbers shown in materials and methods. Signal peptide is in green. Heavy and light chains are shown by orange and black lines, respectively. Ca⁺⁺ binding domains are remarked in pink boxes. Potential N-glycosylation sites (N) and cysteine residues (C) are respectively marked in red and yellow in the respective sequences. Amino acids residues conserved in all the sequences are shown in light grey.

As shown in Table2, the longest porcine CD41 protein shares a 78% amino acid residue identity with those of humans, cattle and horses, 77% with dogs, 75% with rabbits, 73% with rats, 71% with mice, 42% with *Xenopus laevis* and 40% with zebrafish. Table2 also shows the percentages of amino acid residue identities of the different regions of the CD41 molecule. In general, both transmembrane and cytoplasmic domains are more preserved compared to the extracellular one. The phylogenetic tree of CD41 proteins shows that the counterpart closet to porcine CD41 was that of cows (Figure6).

ESPECIES	PROTEIN	EXTRACEL LULAR	TARNMEM BRANE	CYTOPLAS MIC
HUMAN	78	77	80	85
COW	78	77	80	89
HORSE	78	77	80	78
DOG	77	77	80	83
RAT	71	71	84	84
MOUSE	73	72	84	84
RABBIT	75	74	80	80
ZEBRA FISH	40	41	53	55
XENOPUS	42	42	69	40

Table 2. Percentages of amino acids identities between the porcine (Po) and its constitutive blocks with those from humans (Hu), cow (Ca), horse (Ho), dog (Do), rat (Ra), mice (Mi), rabbit (Rb), zebrafish (Zf) and *Xenopus laevis* (Xe).

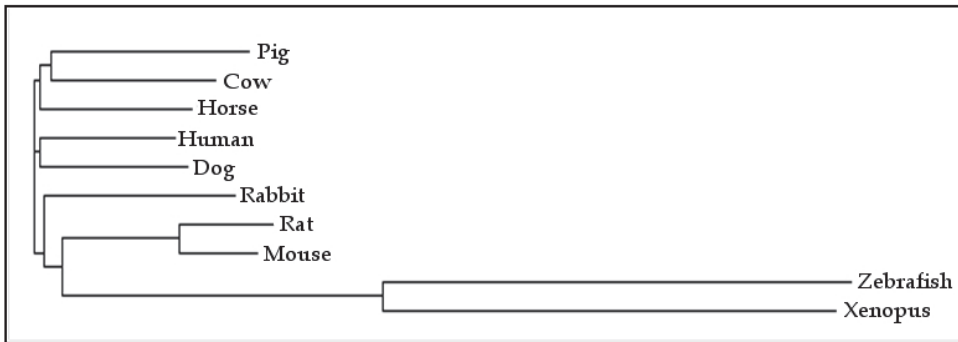

Fig. 6. Phylogenetic tree of the CD41 protein family.

3.3 Chromosome localization of porcine *CD41* gene

Chromosomal localization was carried out screening a pig-rodent somatic hybrid cell panel by PCR, using specific porcine *CD41* primers (Table1). A specific amplification was observed in 9 (16, 20, 21, 22, 23, 24, 25, 26 and 27) of the 27 hybrid cells (Figure7), which enabled us to localize the porcine *CD41* gene in region p11-2/3p13 of chromosome 12 (*Sscr* 12) with a probability of 0.90 and an error margin lower than 0.1% (Chevalet et al., 1997, www.toulouse.inra.fr/lqc/pcr.htm).

The chromosome localization of the gene was confirmed by screening the INRA Minnesota porcine Radiation Hybrid (IMpRH) panel. The IMpRH mapping tool (Milan et al., 2000; www.imprh.toulouse.inra.fr) revealed that porcine *CD41* gene is closely linked to the SW957 marker (47cM; LOD=9) on the *Sscr* 12, p11-p13 region (Figure8).

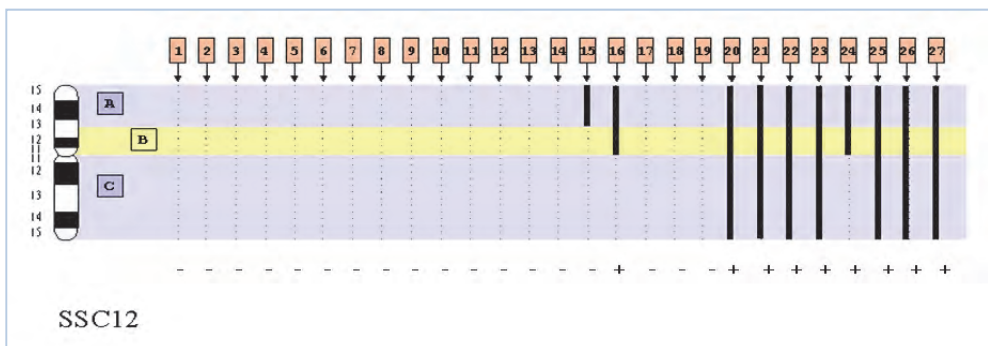

Fig. 7. Diagram showing results for the presence/absence of the *CD41* gene in the INRA somatic hybrid cell panel.

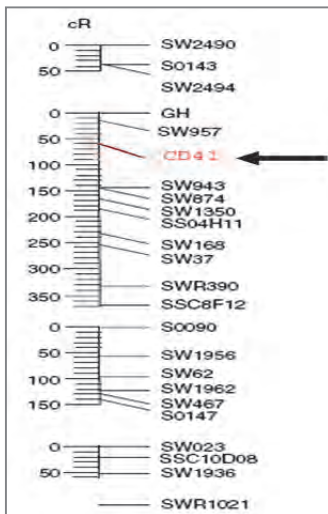

Fig. 8. Diagram showing the chromosomal localization of the *CD41* gene using the INRA Minnesota porcine Radiation Hybrid (IMpRH) panel.

3.4 Cell and tissue expression of porcine *CD41* transcripts

To investigate the pattern of the porcine *CD41* mRNA expression, RT-PCR analysis was conducted with a variety of pig adult tissues and cell types using VARP1/VARP2 gene-specific primers (Table1). The highest level of *CD41* transcripts was detected in platelets, although a moderate level was detected in bone marrow and a low level in ganglions and lungs. No *CD41* transcripts were detected in the rest of tissues and cells analyzed (Figure9).

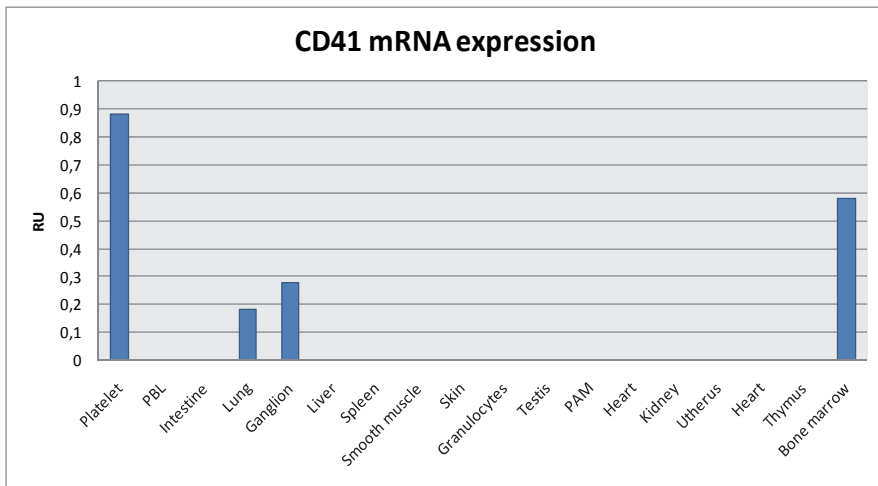

Fig. 9. RT-PCR expression patterns of *CD51* transcripts in different pig cells and tissues. RU: Relative units. 18S RNA amplification was used as control.

3.5 Cell and tissue expression of porcine CD41 proteins

The precise localization of the *CD41* protein was studied by immunohistochemistry and by flow cytometry with antibodies developed against two different porcine CD41 recombinant proteins.

3.5.1 Expression and purification of porcine recombinant CD41 proteins

Two different cDNA fragments belonging to the functional region of the porcine CD41 protein were amplified and subcloned in the *pET-28b* expression vector. One, 996 bp long and amplified with primers CD41-F2 and CD41-R2 (Table1), contained the coding sequence for amino acids 32 to 363, and the other one, 677 bp long and amplified with primers CD41-F1 and CD41-R1, contained the coding sequence for amino acids 684 to 909, a highly antigenic region selected by the Jameson-Wolf method (Jameson & Wolf, 1988). The recombinant constructions, named respectively *pET-F2R2* and *pET-F1R1*, were transfected and expressed in *E. coli* (DE3). Two different recombinant CD41 proteins were purified: rCD41-F1R1 (about 26 kDa) and rCD41-F2R2 (about 46 kDa) (Figure10).

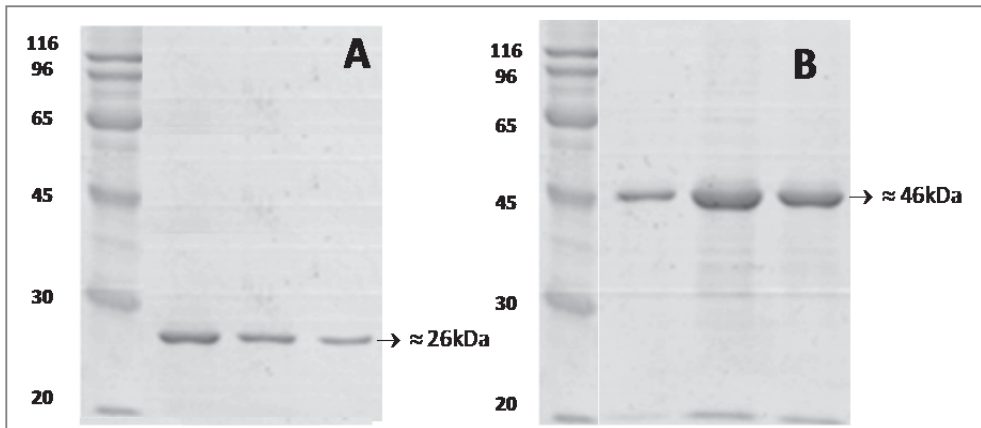

Fig. 10. Purified CD51 recombinant proteins. A: rCD41-F1R1. B: rCD4-F2R2.

3.5.2 Production of antibodies against porcine rCD41 proteins

An anti-rCD41-F2R2 monoclonal antibody (GE2B6), and two anti-rCD41-F2R2 and anti-rCD41-F1R1 polyclonal antibodies were produced, and their specific reactivity against the rCD41 proteins tested in immunoblottings. Before being used in immunohistochemical assays, their ability to specifically recognize the platelet CD41 molecules were carried out through immuno precipitations of platelets lysates in non-reduced conditions. An anti-porcine CD61 (JM2E5), previously produced by us (Pérez de la Lastra et al., 1997), was used as a positive control. Results are shown in Figure11 in which both polyclonal antibodies, the same as JM2E5, identified two proteins of 110 and 90 kDa, corresponding to the α and β chains of the receptor $\alpha_{IIb}\beta_3$. The antibodies α_{IIb} specific recognition was demonstrated through an immunoblotting of platelet lysates in non-reducing conditions (Figure12).

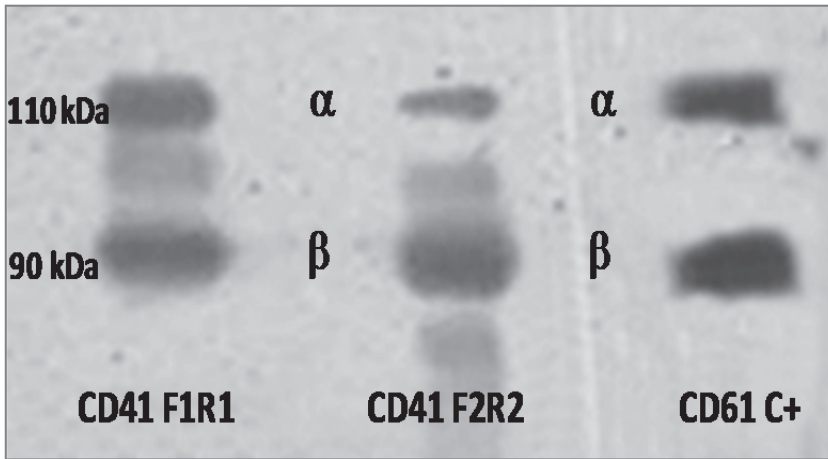

Fig. 11. Immunoprecipitation results of platelet lysates with anti-rCD41-F1R1 and anti-rCD4-F2R2 in non reducing conditions. JM2E5 anti-CD61 antibody was used as a control (C+).

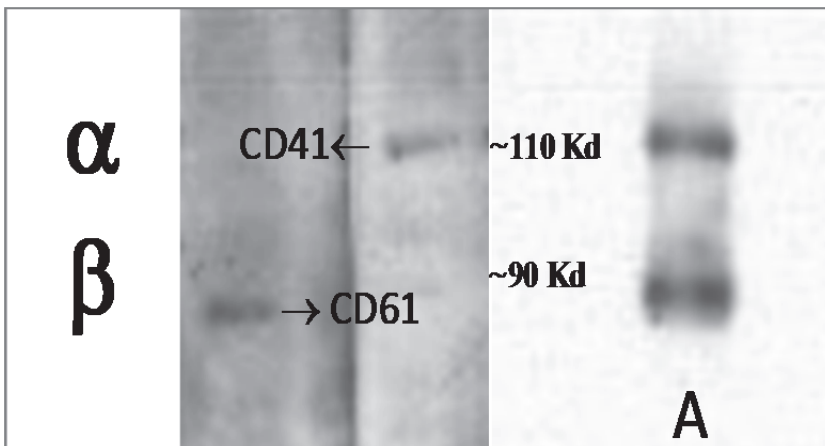

Fig. 12. Immunoblotting results of anti-rCD41-F2R2 and JM2E5 against a porcine platelet lysate.

3.5.3 Immunohistochemical detection of CD41 proteins

The reactivity of the anti-CD41 monoclonal and polyclonal antibodies was tested by immunohistochemistry on a variety of porcine tissues and cells types. Results are shown in Figures 13 and 14. Immunoreactivity was only detected in the membranes of megakaryocytes from bone marrow. No reactivity was detected in any of the tissues checked, including ganglion, in which a weak CD51 transcription was detected by RT-PCR.

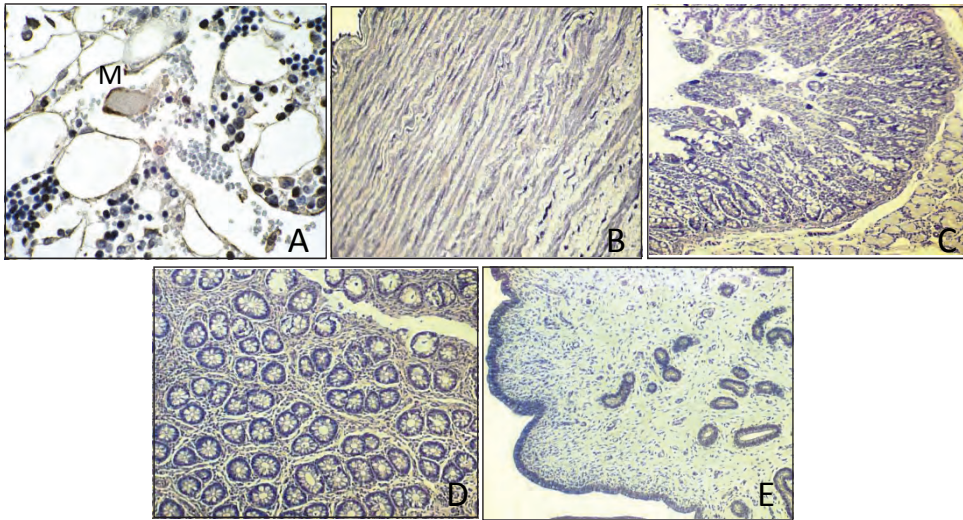

Fig. 13. Immunohistochemistry results with anti-rCD41-F2R2. A: Bone marrow (40X), MK, megakaryocyte. B: Aorta (20X). C: Small intestine (10X). D: Large intestine (10X). E: Uterus (10X).

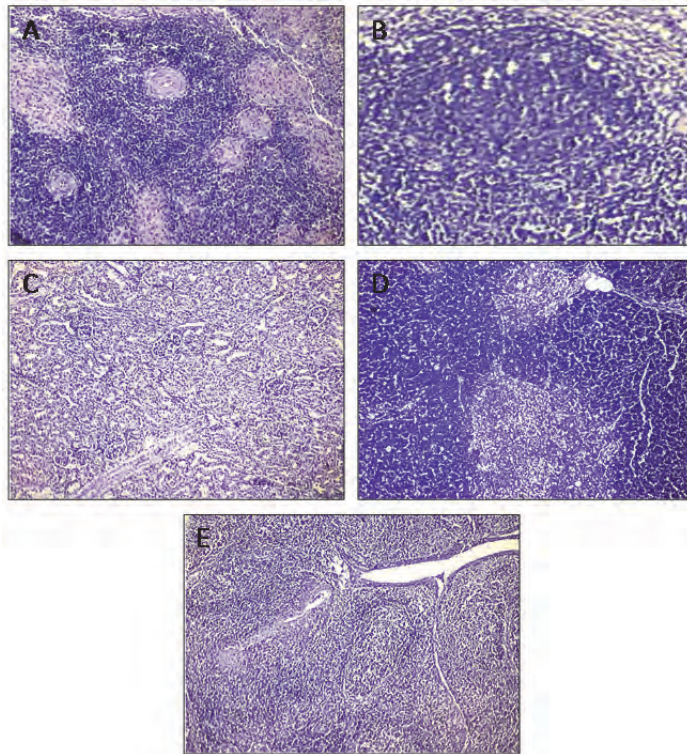

Fig. 14. Immunohistochemistry results with anti-rCD41-F2R2. A: Spleen (2X). B: Ganglion (20X). C: Kidney (10X). D: Thymus (10X). E: Tonsil (10X).

3.5.4 Detection of CD41 proteins by flow cytometry

In order to identify the possible PBL cells that express CD41 proteins we carried out a flow cytometry analysis by using both anti-CD41 polyclonal antibodies. Figure 15 shows the results in platelets, lymphocytes, granulocytes and erythrocytes with anti-CD41-F2R2. CD41 proteins were only detected in platelets by both polyclonal antibodies.

Furthermore, to test the platelet porcine specificity of the antibodies produced in this study we test their reactivity with platelets from pigs, humans, dogs, horses, goats, chats, sheep and cows by flow cytometry. Both anti-CD41-F2R2 and anti-CD41-F1R1 only reacted with porcine platelets (Figure 16), confirming the porcine CD41 specificity of both antibodies.

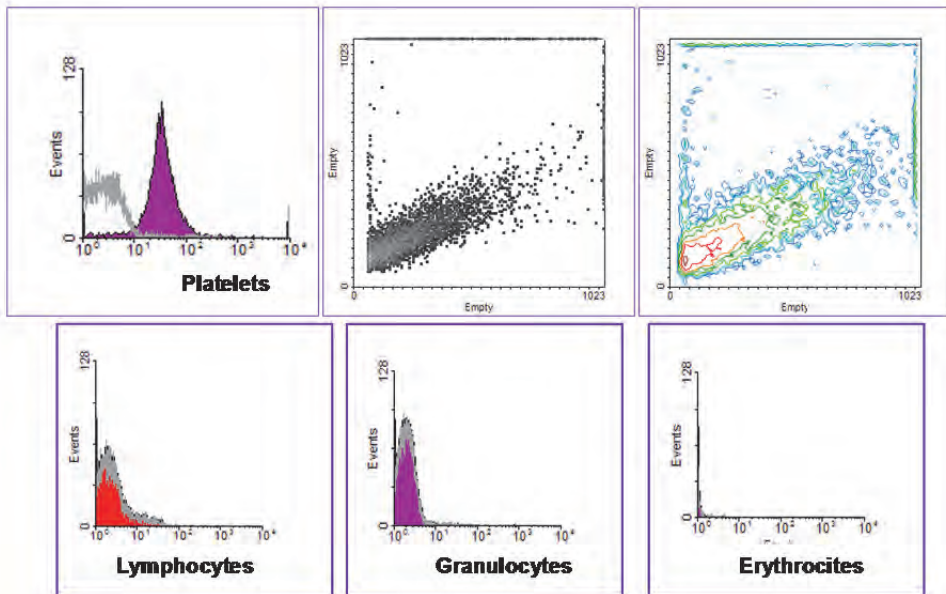

Fig. 15. Flow cytometry with anti-rCD41-F2R2 detecting expression in blood cells.

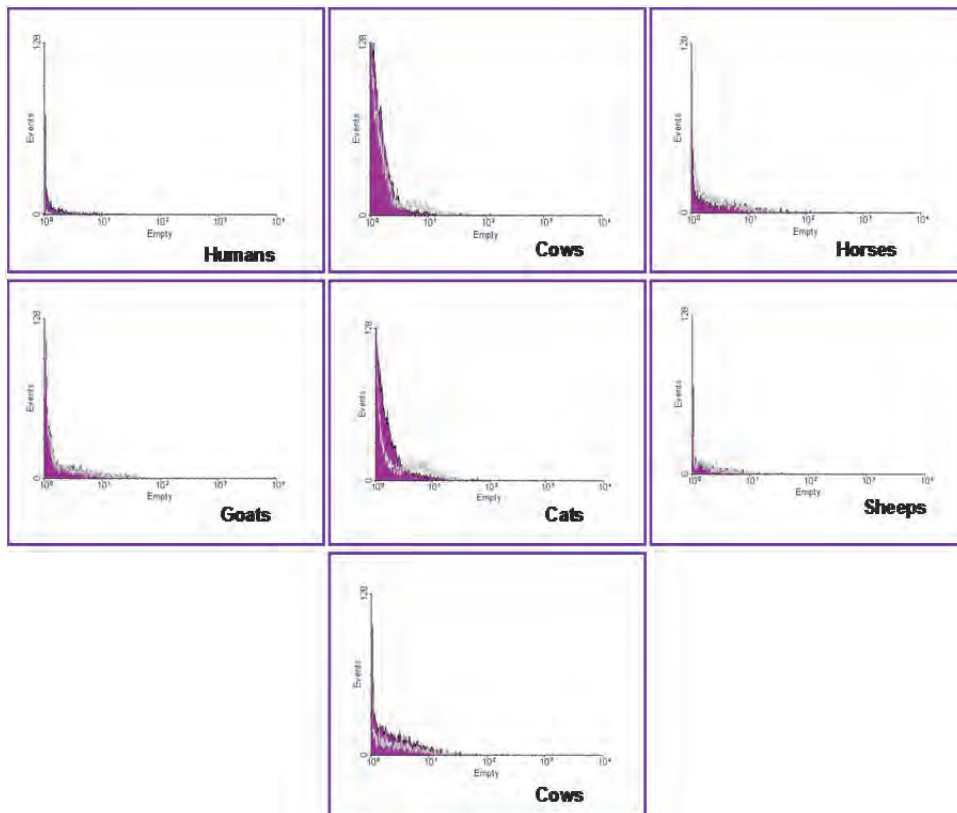

Fig. 16. Flow cytometry with anti-rCD41-F2R2 showing no CD41 expression in platelets from different mammals.

3.6 Effect of the platelet activation on the expression of porcine CD41

Previous results obtained in our lab using a two dimension differential in gel electrophoresis (2D-DIGE) technique had shown that the proteome of thrombin activated porcine platelets showed a reduced number of proteins affected in their expression level, among which CD41 was not found. Although CD41 is strongly expressed in platelets, the membrane proteins are usually poorly represented in the gels as a consequence of their high hydrophobicity. As we had produced specific anti-CD41 polyclonal antibodies, we used the anti-rCD41-F2R2 to check, using immunoblotting, if CD41 was or not present in a similar gel than that used in our previous study. Results are shown in Figure 17 in which CD41 integrin was clearly detected.

In order to test if the *CD41* transcripts level was or not modified in the platelets after activation by thrombin, we carried out a real time quantitative PCR (rt-q-PCR) with RNAs from unstimulated and stimulated platelets. Results are shown in Figure 18 in which a higher but not significant change in the *CD41* transcripts level was detected after the activation by thrombin (the significant value is 1.5). Three replicates were assayed with very similar results.

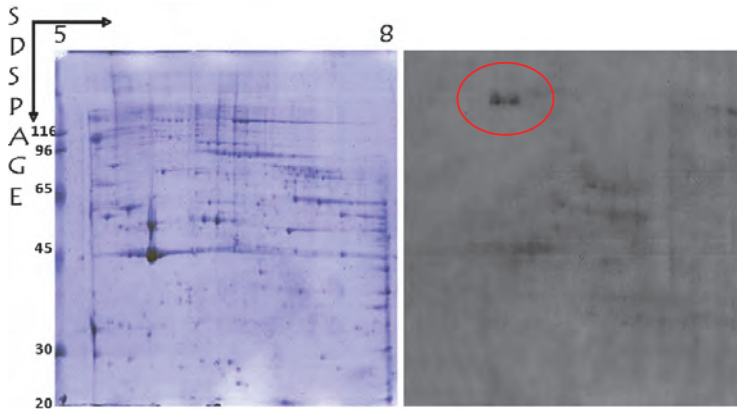

Fig. 17. A: Two dimension gel electrophoresis showing the platelet proteome stained with Coomassie blue. B: Immunoblotting of platelet proteome with anti-rCD41-F2R2. Red circle shows detection of CD41 protein.

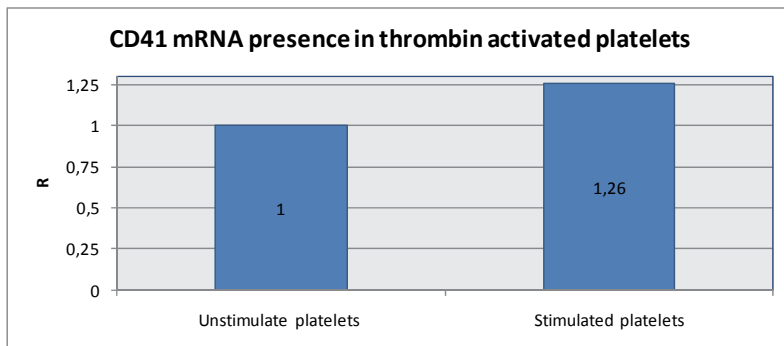

Fig. 18. Real time quantification of CD51 transcripts in unstimulated and thrombin stimulated platelets. R: Ratio (relative abundance to β -actin mRNA). Results represent the average of three replicates.

4. Discussion

In general, the study of genes expressed in platelets is difficult since platelets are enucleated cells that show a reduced level of protein synthesis, and megakaryocytes, the platelets precursors, represent only 0.1% of bone marrow cells (Bray et al., 1987). Nevertheless, in the present study we describe for first time the cloning and characterization of the full-length cDNA for the porcine CD41 (α_{IIb}) integrin chain.

The porcine CD41 proteins share common structural elements, including cytoplasmic, transmembrane and extracellular domains and the position of the proteolytic cleavage sites with the CD41 protein of other species. The porcine CD41 integrin showed an average of 75% amino acid identity with their mammal orthologous molecules, being the conservation in the transmembrane and cytoplasmic regions higher than in the extracellular one in all the

species compared. The phylogenetic tree of CD41 family of proteins showed that the closest to porcine CD41 were those of cows and horses, and that the clusters of domestic mammals showed the less divergence in evolution. However, compared with other α mammal integrins, like α_v which show 90% of identity (Yubero et al., 2011), α_{IIb} integrins show lower level of conservation, which could be associated with the number of β chains with which they can form receptors: only one (β_3) for α_{IIb} , and at least five for α_v .

Porcine CD41 conserves all the main structural characteristics that define their functions in other species. The extracellular domain shows that porcine CD41 belongs to α integrins lacking I domain, a domain present in the NH₂ extreme of some integrins, like α_1 , α_2 or β_2 , which contains the functional sites to bind to ligands (Dickeson & Santoro, 1998; Humphries, 2000). Porcine and human α_{IIb} , the same as α_v , α_5 and α_8 ones, spreads the ligand binding sites among the first 334 NH₂ amino acid residues (Loftus et al., 1996). One characteristic of the α integrins lacking I domain is the presence of the seven FG-GAP tandem repeat sequences (W₁ to W₇; see Figures 3 and 4). Each FG-GAP sequence determines four antiparallel β chains, and the folding of all the seven FG-GAP sequences establishes the globular structure of the integrin, which contains the ligand binding sites. Fibrinogen is the main ligand for $\alpha_{IIb}\beta_3$ complex. In humans, the binding of fibrinogen to $\alpha_{IIb}\beta_3$ receptor requires the α_{IIb} chain Ala₂₉₄ to Met₃₁₄ residues, which are located in the third FG-GAP repeat (D'Souza et al., 1990). Other experiments, including molecular characterization of the Glanzmann thrombasthenia and mutagenesis analysis, have shown that residues Ala₁₄₅, Asp₁₆₃, Leu₁₈₃, Glu₁₈₄, Tyr₁₈₉, Tyr₁₉₀, Phe₁₉₁ and Asp₂₂₄ of the α_{IIb} chain, are also critics for the fibrinogen binding (Grimaldi et al., 1998; Honda et al., 1998; Tozer et al., 1999). The comparison between human and porcine α_{IIb} integrin sequences showed that all these critic residues are conserved in the porcine molecule.

On the other hand, the fibrinogen only binds to the activated $\alpha_{IIb}\beta_3$ integrins, this activation being mediated by Ca⁺⁺ (Bennett & Vilaire, 1979). The molecular characterization of α_{IIb} carried out in this study showed that all the four Ca⁺⁺ binding domains (consensus sequence DX[D/N]XDGXXD) were also highly conserved in the porcine α_{IIb} integrin when compared to that in humans.

The transmembrane region of the porcine α_{IIb} integrin is also highly conserved when compared to their homologous mammalian (80-84% of identity). The sequence GXXXG in this region is essential for a high affinity association of the transmembrane helices (Senes et al., 2000). Changes as AXXXG or SXXXG in this sequence reduce significantly the affinity between them (Mendrola et al., 2002; Schneider & Engelman, 2004). Our results showed that the same GVLGG sequence was conserved in the α_{IIb} integrins from all the mammalian species compared, including that of the pig. It has been suggested and supported a "push-pull" mechanism for $\alpha_{IIb}\beta_3$ regulation in which the destabilization of the heterodimeric α_{IIb} and β_3 transmembrane interactions push $\alpha_{IIb}\beta_3$ to its activated state, whereas processes that favor their homomeric association pull $\alpha_{IIb}\beta_3$ toward its active conformation (Li et al., 2005; Yin et al., 2006). This is in concordance with the high conservation of the GVLGG sequence in the transmembrane region of the porcine (and other mammal) α_{IIb} chains, since fibrinogen binding to $\alpha_{IIb}\beta_3$ is a prerequisite for platelets aggregation (Bennett, 2005). It is worthy to note that the porcine α_v integrin, also present in platelets membranes, contains an AVLGG sequence in the transmembrane region, as well as in all their mammalian homologous with which it was compared (Yubero et al, 2011).

The cytoplasmic region of the porcine α_{IIb} integrin is also highly conserved (80-89% of identity when compared to their homologous mammals). A short GFFKR motif, which was involved in the activation of the integrin receptors, is present in the cytoplasmic region of all the human α integrins. In humans, mutations in the GFFKR motif of the $\alpha_{IIb}\beta_2$ integrin receptor induce a permanent activation of the integrins. As expected, in all the species compared in this study, the porcine α_{IIb} integrin contains this motif near to the transmembrane region. The porcine α_{IIb} integrin also contains in the cytoplasmic region the PPLEE motif, present in all the mammalian α_{IIb} integrin compared in this study, whose modifications determine changes that interfere with the specific recognizing of the ligands (Filardo & Cheresch, 1994).

Once the porcine α_{IIb} integrin was characterized, we used a porcine radiation hybrid panel and a somatic cell hybrid panel to map the pig *CD41* (α_{IIb}) gene into swine chromosome 12 (*Sscr 12*), region p11(2/3)-p13. This chromosomal localization is in total concordance with heterologous painting data that demonstrate the correspondence between the swine *Sscr 12* and the human *Hsap 17* chromosomes (Rettenberger et al., 1995), where *CD41* (α_{IIb}) gene maps in the human *Hsap 17* q21 region (Bray et al., 1987), homologous to the porcine *Sscr 12* p11-p13 one (Figure 19).

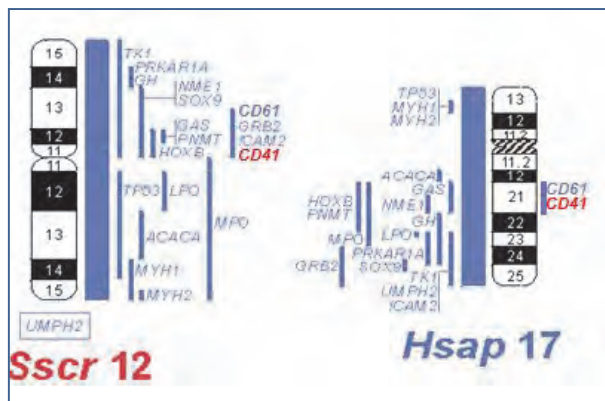

Fig. 19. Chromosomal localization of porcine and human *CD41* genes showing the correspondence between porcine *Sscr 12* and human *Hsap 17* chromosomes.

It is interesting to note that the swine *CD41* (α_{IIb}) and *CD61* (β_3) genes are closely located - which confirms our previous results (Morera et al., 2002)-, the same as in humans, where both genes map together in chromosome 17, q21 region (Thornton & Poncz, 1999). This is exceptional for genes coding for α and β integrins belonging to the same receptor, and it must have a functional significance, as both genes are simultaneously expressed in human megakaryocytes (Bennett et al, 1983). Therefore, the chromosomal assignment of pig *CD41*(α_{IIb}) gene provides additional evidence of the conserved linkage homology in these chromosome regions among pigs and humans.

We also checked in this study the porcine α_{IIb} expression profile in different cells and tissues. When we used RT-PCR to detect the α_{IIb} transcripts level, we observed, as expected, a strong expression in platelets and in bone marrow. However, we also detected a lower expression in lymphatic ganglion and lung, which we explain by the probable

presence of platelets or blood cells in them. When we used immunohistochemistry and flow cytometry to locate accurately the CD41 (α_{IIb}) protein expression with specific antibodies produced by us, we confirmed that the presence of CD41 proteins was restricted to platelets and megakaryocytic membranes. The same restricted expression pattern of α_{IIb} proteins have been detected in other species, like humans and mice, although some studies suggest that α_{IIb} could be a differentiation marker expressed in early stages of the cellular hematopoietic differentiation (Mitjavila-García et al., 2002) or to be over expressed in tumor cells (Raso et al., 2004). In fact, the α_{IIb}/β_3 integrin expression in tumor cells has been controversial as α_{IIb} and α_v integrin have similar structures, and although the role of the CD51 integrin in tumor metastasis and angiogenesis is well documented (Chen, 1992, 1997; Mitjans et al., 2000), these studies have been carried out using antibodies that could cross react with the α_v/β_3 receptor (Chen et al., 1992; Chen 2006). However, some studies have revealed that the α_{IIb}/β_2 receptor mediates interactions between platelets and tumor cells, detecting an over expression in the filopodia emitted by the platelets in the focal adhesion plates, with the filopodia being the first contact sites between tumor cells and platelets (Chopra et al., 1992).

In this sense, it is worthy to note that in our study we have produced the two first specific anti-porcine α_{IIb} antibodies, whose specificities we have demonstrated by flow cytometry in cross reactions against platelets from humans, dogs, horses, goats, cats, sheep and cows.

Finally, as α_{IIb}/β_3 is involved in adhesion and aggregation of platelets after their activation, we checked if the platelet activation was or not associated with changes in the α_{IIb} transcripts level. Changes in the proteome of platelet activated by thrombin, the strongest platelet activator, was previously studied in our laboratory, detecting some differential modification in only a small number of proteins, among which the CD41 integrin was not included, even though a very sensitive two dimension differential in gel electrophoresis (2D-DIGE) technique was used (Esteso et al., 2008). As CD41 is strongly represented in platelets and it plays an essential role in their activation, we took advantage of the specific anti-porcine α_{IIb} antibodies produced for the studies presented in this chapter to check if CD41 integrin was or not present in the gels used to carry out those studies. Immunoblotting results clearly showed that CD41 protein was detected in the platelet proteome, which confirmed our previous results that showed that platelets did not modify their CD41 protein level after thrombin activation. Moreover, although platelets are enucleated cells that lack their nucleus during the megakaryocytic cells cytoplasm fragmentation, it is well established that they conserve ribosomes, mRNAs, as well as the post-translationally modifying protein mechanisms (Dittrich et al., 2005). For this, we used a real time PCR to check if some change was produced in the α_{IIb} transcripts level as a consequence of the platelet activation by thrombin. Results showed that although a small increase was detected, this was not statistically significant. It is well established that most changes produced after platelets activation involve post-translational modifications that affect the interactions between transmembrane and cytoplasmic domains of α and β chains (Russ & Engelman, 1999). So, our results support that the changes produced after thrombin platelet activation, which seems to disrupt the helical interface between the integrin α and β subunit transmembrane domains, favoring homomeric α_{IIb} (and β_3) transmembrane domain interactions in the $\alpha_{IIb}\beta_3$ receptor (Luo et al., 2004; Li et al., 2005; Partridge et al., 2005; Yin et al., 2006), must be produced by post-translational regulation, without affecting neither the transcript nor the protein level in the α_{IIb} .

5. Conclusion

Integrins are a family of heterodimeric transmembrane glycoproteins consisting of varying combinations of noncovalently bound α and β chains that generate several receptors with different expression patterns and ligand binding profiles. $\alpha_{IIb}\beta_3$ (CD41/CD61) integrin is the most abundant platelet receptor being responsible for the platelet aggregation. Most of the studies with $\alpha_{IIb}\beta_3$ integrin have been carried out in humans and mice but little is known about the expression of $\alpha_{IIb}\beta_3$ integrin in porcine tissues, although pig is generally accepted as an optimal experimental model for different areas, as cardiovascular diseases, because of its similarity to humans. We have previously cloned and characterized the porcine gene coding for the β_3 (CD61) chain of the $\alpha_{IIb}\beta_3$ integrin; however, the one coding for α_{IIb} (CD41) chain -the only α subunit for the β_3 one- remained to be characterized.

We describe in this chapter the molecular cloning, the structural and comparative analysis, and the expression patterns of the porcine gene coding for the α_{IIb} integrin chain. Additionally, we also describe the chromosomal localization of the gene.

We used a combined strategy of PCR and RACE reactions to obtain a full porcine α_{IIb} cDNA sequence from platelet RNA. The pig α_{IIb} cDNA was 3336-pb long and contained an ORF 3111 b long that encodes a pre- α_{IIb} protein composed by 1036 amino acid residues, from which, 961, 26 and 10 belong to the NH₂-extracellular, the transmembrane and the cytoplasmic-COOH domains, respectively. The porcine α_{IIb} shares with α_{IIb} from other species: identical structure, a high % amino acid identity, common domains (α -I, Ca⁺⁺ binding, MIDAS), N-glycosylation sites, and the seven FG-GAP tandem repeats. However, in relation to other mammalian α chains, the porcine α_{IIb} shares lower identities with those homologous in mammals (78% with humans, horses and cows, 78% with dogs, 75% with rabbits, 73% with mice and 71% with rats). A phylogenetic tree identifies cows CD41 as the closest to pigs.

By using both somatic cell hybrid and irradiated cell hybrid panels, we localized the gene coding for the porcine α_{IIb} integrin in chromosome *Sscr* 12 region p11-(2/3 p13), in the same region where we previously localized the porcine β_3 integrin gene, region that corresponds to the human homologous *Hsap* 17(q21) in chromosome 17.

As expected, the porcine α_{IIb} mRNAs were predominantly detected in platelets, but they were also detected in bone marrow and ganglion, in which platelets or megakaryocytes -the platelets precursors- were probably presents. To locate accurately the pattern expression of the α_{IIb} protein, immunohistochemical, immunocytochemical and flow cytometry analysis were carried out. For this, monoclonal and polyclonal antibodies against porcine recombinant α_{IIb} integrins (r α_{IIb}) were previously produced. Citometry flow analysis determined the antibodies specificity for porcine platelets, being the first antibodies described with this characteristic. Immunohistochemical assays confirmed that the α_{IIb} expression is restricted to the membranes of megacariocytes present in bone marrow. Flow cytometry analysis of PBC confirmed the α_{IIb} expression in platelet but not in lymphocytes, erythrocytes or granulocytes.

Finally, we checked by RT-Q-PCR if any change was produced in the level of α_{IIb} transcripts in thrombin activated platelets, no detecting significant ones. This result, together to previous ones obtained by us, support that no change were produced in neither the transcript nor the protein level of α_{IIb} , supporting α_{IIb} post-translational changes in the $\alpha_{IIb}\beta_3$ platelet receptor after thrombin activation.

In conclusion, our results are of particular interest because the pig is an animal model system for a variety of immunological, developmental and pathological studies, and because α IIb integrin plays an essential role in phenomena so significant as thrombosis, homeostasis, tumors progression and invasion, and differentiation of cells from the myeloid lineage in the bone marrow.

6. References

- Alam N, Goel HL, Zarif MJ, Butterfield JE, Perkins HM, Sansoucy BG, Sawyer TK & Languino LR, (2007). The integrin-growth factor receptor duet. *Journal of Cellular Physiology*, Vol.213, pp. 649–653.
- Arce, C., Moreno, A., Millán, Y., Martín de las Mulas, J. & Llanes, D. (2002). Production and characterization of monoclonal antibodies against dog immunoglobulin isotypes. *Vet. Immunol. Immunopathol.*, Vol.6, No.88(1-2), pp. 31-41.
- Bennett, J.S. & Vilaire, G. (1979). Exposure of platelet fibrinogen receptors by ADP and epinephrine. *J. Clin. Invest.*, Vol.64, pp. 1393-1401.
- Bennett, J. S., Hoxie, J. A., Leitman, S. F., Vilaire, G. & Cines, D. B. (1983). Inhibition of fibrinogen binding to stimulated human platelets by a monoclonal antibody. *Proc. Natl. Acad. Sci. USA*, Vol.80, pp. 2417-2421.
- Bennett, J.S. (2005). Structure and function of the platelet integrin α IIb/ β 3. *J. Clin. Invest.*, Vol.115, pp. 3363-3369.
- Bray, P.F., Rosa, J.P., Johnson, G.L, Shiu, D.T., Cook, R.G., Lau, C., Kan, Y.W., McEver, R.P. & Shuman, M.A. (1987). Platelets glycoprotein IIb. Chromosomal localization and tissue expression. *J. Clin. Invest.*, Vol.80, pp. 1812-1817.
- Chen, Y. P., Djaffar, I., Pidad, D., Steiner, B., Cieutat, A. M., Caen, J. P. & Rosa, J. P. (1992). Ser-752-->Pro mutation in the cytoplasmic domain of integrin beta 3 subunit and defective activation of platelet integrin alpha IIb beta 3 (glycoprotein IIb-IIIa) in a variant of Glanzmann thrombasthenia. *Proc. Natl. Acad. Sci. USA*, Vol.89, pp. 10169-10173.
- Chen, Y. Q., Trikha, M., Gao, X., Bazaz, R., Porter, A. T., Timar, J. & Honn, K. V. (1997). Ectopic expression of platelet integrin α IIb β 3 in tumor cells from various species and histological origin. *Int. J. Cancer*, Vol.72, pp. 642-648.
- Chen, X. (2006). Multimodality imaging of tumor integrin α IIb β 3 expression. *Mini Rev Med Chem* Vol.6, pp. 227-234.
- Chevalet, C., Gouzy, J. & SanCristobal-Gaudy, M. (1997). Regional assignment of genetic markers using a somatic cell hybrid panel: a WWW interactive program available for the pig genome. *Comput. Appl. Biosci.*, Vol.13, pp. 69-73.
- Chopra, H., Timar, J., Rong, X., Grossi, I. M., Hatfield, J. S., Fligel, S. E., Finch, C. A., Taylor, J. D. & Honn, K. V. (1992). Is there a role for the tumor cell integrin α IIb β 3 and cytoskeleton in tumor cell-platelet interaction? *Clin. Exp. Metastasis*, Vol.10, pp. 125-137.
- Clark, E. A. & Brugge J. S. (1995). Integrins and signal transduction pathways: the road taken. *Science*, Vol. 268, pp.233-239.
- Corbel, C. & Salaun, J. (2002). α IIb integrin expression during development of the murine hemopoietic system. *Dev. Biol.*, Vol.243, pp. 301-311.
- Dickeson, S. K., & Santoro, S. A. (1998). Ligand recognition by the I domain-containing integrins. *Cell Mol. Life Sci.*, Vol.54, pp. 556-566.
- Dittrich, M., Birschmann I, Stuhlfelder C, Sickmann A, Herterich S, Nieswandt B, Walter U. & Dandekar T. (2005). Understanding platelets. *Thromb. Haemost.*, Vol.94, pp. 916–25.

- D'Souza, S. E., Ginsberg, M. H., Burke, T. A. & Plow, E. F. (1990). The ligand binding site of the platelet integrin receptor GPIIb-IIIa is proximal to the second calcium binding domain of its alpha subunit. *J. Biol. Chem.*, Vol.265, pp. 3440-3446.
- Edgar, R.C.(2004). MUSCLE: a multiple sequence alignment method with reduced time and space complexity. *BMC Bioinformatics*, Vol.19, pp. 5, 113.
- Esteso, G., Mora, M.I., Garrido; J.J., Corrales, F. & Moreno, A. (2008). Proteomic analysis of the porcine platelet proteome and alterations induced by thrombin activation. *Journal of Proteomics*, Vol.71, pp. 547-560.
- Filardo, E.J. & Cheresch, D.A. (1994). A β turn in the cytoplasmic tail of the integrin αv subunit influences conformation and ligand binding of $\alpha v\beta 3$. *J. Biol. Chem.*, Vol.269, pp. 4641-4647.
- García A, Prabhakar S, Brock C, Pearce A, Dwek R, Watson S., Hebestreit H, & Zitzmann N. (2004). Extensive analysis of the human platelet proteome by two-dimensional gel electrophoresis and mass spectrometry. *Proteomics*, Vol.4, pp. 656-68.
- Grimaldi, C.M., Chen, F., Wu, C., Weis, H.J., Collier, B.S. & French, D.L. (1998). Glycoprotein IIb Leu214Pro mutation produces glanzmann thrombasthenia with both quantitative and qualitative abnormalities in GPIIb/IIIb. *Blood*, Vol.91, pp. 1562-1571.
- Hawken, R. J., Murtaugh, J., Flickinger, G. H., Yerle, M., Robic, A., Milan, D., Gellin, J., Beattie, C. W., Schook, L. B. & Alexander, L. J. (1999). A first-generation porcine whole-genome radiation hybrid map. *Mamm. Genome*, Vol.10, pp. 824-830.
- Hemler, M.E., Weitzman, J.B., Pasqualini, R., Kawaguchi, S., Kassner, P.D., & Berditchevsky, F.B. (1994). Structure, biochemical properties, and biological functions of integrin cytoplasmic domains. In *Integrins: The Biological Problems*. Y. Takada, editor. CRC Press, Boca Raton, FL, pp. 1-35.
- Honda, S., Tomiyama, Y., Shiraga, M., Tadokoro, S., Takamatsu, J., Saito, H., Kurata, Y. & Matsuzawa, Y. (1998). A two-amino acid insertion in the Cys146- Cys167 loop of the α IIb subunit is associated with a variant of Glanzmann thrombasthenia. Critical role of Asp163 in ligand binding. *J. Clin. Invest.*, Vol.102, pp. 1183-1192.
- Humphries, M. J. (2000). Integrin structure. *Biochem. Soc. Trans.*, Vol.28, pp. 311-339.
- Hynes, R.O., 1987. Integrins: a family of cell surface receptors. *Cell*, Vol.48, pp. 549-554.
- Hynes, R. O. (1992). Integrins: versatility, modulation, and signaling in cell adhesion. *Cell*, Vol.69, pp. 11-25.
- Hynes, R. O. (2002). Integrins: bidirectional, allosteric signaling machines. *Cell*, Vol.110, pp. 673-687.
- Hynes, R.O., Lively, J.C., McCarty, J.H., Taverna, D., Xiao, Q. & Hodivala-Dilke, K. (2002). The diverse roles of integrins and their ligands in angiogenesis. Cold Spring Harb. Symp. *Quant. Biol.*, Vol.67, pp. 143-153.
- Isenberg, G. (1991). Actin binding proteins - lipid interactions. *Journal of Muscle Research and Cell Motility*. Vol.12, pp. 136-144.
- Jameson, B. A. & Wolf, H. (1988). The antigenic index: a novel algorithm for predicting antigenic determinants. *Comput. Appl. Biosci.* Vol.4, pp. 181-186.
- Jiménez-Marín, A., Garrido, J.J, De Andrés, D.F., Morera, L., Llanes, D. & Barbancho, M. (2000). Molecular cloning and characterization of the pig homologue to human CD29, the integrin $\beta 1$ subunit. *Transplantation*, Vol.70, No.4, pp.649-655.
- Jiménez-Marín, A., Yubero, N., Esteso, G., Moreno, A., de Las Mulas, J. M., Morera, L., Llanes, D., Barbancho, M. & Garrido, J. J. (2008). Molecular characterization and expression analysis of the gene coding for the porcine beta(3) integrin subunit (CD61). *Gene*, Vol.408, pp. 9-17.

- Li, W., Metcalf, D. G., Gorelik, R., Li, R. H., Mitra, N., Nanda, V., Law, P. B., Lear, J. D., DeGrado, W. F., and Bennett, J. S. (2005). A Push-Pul mechanism for integrin function. *Proc. Natl. Acad. Sci. U SA*, Vol.102, pp. 1424-1429.
- Loftus, J. C., Halloran, C. E., Ginsberg, M. H., Feigen, L. P., Zablocki, J. A. & Smith, J. W. (1996). The amino-terminal one-third of alpha IIb defines the ligand recognition specificity of integrin alpha IIb beta 3. *J. Biol. Chem.*, Vol.271, 2033-2039.
- Lunney, J.K., 2007. Advances in swine biomedical model genomics. *Int. J. Biol. Sci.*, Vol.3, No.3, pp. 179-184.
- Luo, B.H., Springer, T.A. & Takagi, J. (2004) A specific interface between integrin transmembrane helices and affinity for ligand. *PLoS Biol.*, Vol.2, e153.
- Mendrola, J.M., Beger, M.B., King, M.C. & Lemmon (2002). The single transmembrane domains of ErbB receptors self-associate in cell membranes. *J. Biol. Chem.*, Vol.277, pp. 4704-4712.
- Mitjans, F., Meyer, T., Fittschen, C., Goodman, S., Jonczyk, A., Marshall, J.F., Reyes, G. & Piulats, J. (2000). In vivo therapy of malignant melanoma by means of antagonists of alfav integrins. *Int. J. Cancer* Vol.87, pp. 716-723.
- Misdorp, W. (2003). Congenital and hereditary tumors in domestic animals, 2. Pigs: a review. *Vet. Q.*, Vol.25, pp. 17-30.
- Mitjavila-Garcia, M. T., Cailleret, M., Godin, I., Nogueira, M. M., Cohen-Solal, K., Schiavon, V., Lecluse, Y., Le Pesteur, F., Lagrue, A. H. & Vainchenker, W. (2002). Expression of CD41 on hematopoietic progenitors derived from embryonic hematopoietic cells. *Development*, Vol.129, pp. 2003-2013.
- Morera, L., Jiménez-Marín, A., Yerle, M., Llanes, D., Barbancho, M. & Garrido, J.J. (2002). A polymorphic microsatellite located on pig chromosome band 12p11-2/3p13, within the 3'-UTR of the ITGB3 gene. *Animal Genetics*, Vol.33, pp. 239-240.
- Ody, C., Vaigot, P., Quere, P., Imhof, B. A. & Corbel, C. (1999). Glycoprotein IIb-IIIa is expressed on avian multilineage hematopoietic progenitor cells. *Blood*, Vol.93, pp. 2898-2906.
- Partridge, A.W., Liu, S., Kim, S., Bowie, J.U. & Ginsberg, M.H. (2005). Transmembrane domain helix packing stabilizes integrin α IIb β 3 in the low affinity state. *J. Biol. Chem.*, Vol.280, pp. 7294-7300.
- Pérez de la Lastra, J.M., Moreno, A., Pérez, J., Llanes, D. (1997). Characterization of the porcine homologue to human platelet glycoprotein IIb-IIIa (CD41/CD61) by a monoclonal antibody. *Tissue Antigens*, Vol.49, pp. 588-594.
- Raso, E., Dome, B., Somlai, B., Zacharek, A., Hagman, W., Honn, K.V. & Timar, J. (2004). Molecular identification, localization and function of platelet-type 12 lipoxygenase in human melanoma progression, under experimental and clinical conditions. *Melanoma Res.*, Vol.14, pp. 245-250.
- Rettenberger, G., Klett, C., Zechner, U., Kunz, J., Vogel, W. & Hameister, H. (1995). Visualization of the conservation of synteny between humans and pigs by heterologous chromosomal painting. *Genomics*, Vol.26, pp. 372-378.
- Rojiani, M.V., Finlay, B.B., Gray, V. & Dedhar, S. (1991). In vitro interaction of a polypeptide homologous to the human Ro/SS-A antigen (calreticulin) with a highly conserved amino acid sequence in the cytoplasmic domain of integrin alpha subunits. *Biochemistry*, Vol.30, pp. 9859-9866.
- Russ, W.P. & Engelman, D.M. (1999). TOXCAT: a measure of transmembrane helix association in a biological membrane. *Proc. Natl. Acad. Sci. USA*, Vol.96, pp. 863-868.

- Schneider, D. & Engelman, D. M. (2004). Involvement of transmembrane domain interactions in signal transduction by alpha/beta integrins. *J. Biol. Chem.*, Vol.279, pp. 9840-9846.
- Senes, A., Gerstein, M. & Engelman, D. M. (2000). Statistical analysis of amino acid patterns in transmembrane helices: the GxxxG motif occurs frequently and in association with beta-branched residues at neighboring positions. *J. Mol. Biol.*, Vol.296, pp. 921-936.
- Springer, T. A. (1997). Folding of the N-terminal, ligand-binding region of integrin alpha-subunits into a beta-propeller domain. *Proc. Natl. Acad. Sci. USA*, Vol.94, pp. 65-72.
- Schwartz, M. A., Schaller, M. D. & Ginsberg, M. H. (1995). Integrins. Emerging paradigms of signal transduction. *Annu. Rev. Cell Dev. Biol.*, Vol.11, pp. 549-599.
- Takada, Y., Elices, M. J., Crouse, C. and Hemler, M. E. (1989). The primary structure of the alpha 4 subunit of VLA-4: homology to other integrins and a possible cell-cell adhesion function. *Embo J.*, Vol.8, pp. 1361-1368.
- Thornton, M. A. & Poncz, M. (1999). Characterization of the murine platelet alphaIIb gene and encoded cDNA. *Blood*, Vol.94, pp. 3947-3950.
- Tozer, E.C., Baker, E.K., Ginsberg, M.H. & Loftus, J.C. (1999). A mutation in the alpha subunit of the platelet integrin alphaIIb beta3 identifies a novel region important for ligand binding. *Blood*, Vol.93, pp. 918-924.
- Wall, C. D., Conley, P. B., Armendariz-Borunda, J., Sudarshan, C., Wagner, J. E., Raghov, R. & Jennings, L. K. (1997). Expression of alpha IIb beta 3 integrin (GPIIb-IIIa) in myeloid cell lines and normal CD34+/CD33+ bone marrow cells. *Blood Cells Mol. Dis.*, Vol.23, pp. 361-376.
- Weiss, E. J., Bray, P. F., Tayback, M., Schulman, S. P., Kickler, T. S., Becker, L. C., Weiss, J. L., Gerstenblith, G. & Goldschmidt-Clermont, P. J. (1996). A polymorphism of a platelet glycoprotein receptor as an inherited risk factor for coronary thrombosis. *N. Engl. J. Med.*, Vol.334, pp. 1090-1094.
- Xiong, J.P., Stehle, T., Diefenbach, B., Zhang, R., Dunker, R., Scott, D.L., Joachimiak, A., Goodman, S.L., Amin, M. & Arnaout, M.A. (2001). Crystal structure of the extracellular segment of integrin alphaV beta3. *Science*, Vol.294, pp. 339-345.
- Yamada, K.M., 1991. Adhesive recognition sequences. *J. Biol. Chem.*, Vol.266, pp. 12809-12812.
- Yerle, M., Echarid, G., Robic, A., Mairal, A., Dubut-Fontana, C., Riquet, J., Pinton, P., Milan, D., Lahbib-Mansais, Y. & Gellin, J. (1996). A somatic cell hybrid panel for pig regional gene mapping characterized by molecular cytogenetics. *Cytogenet. Cell Genet.*, Vol.73, pp. 194-202.
- Yerle, M., Pinton, P., Robic, A., Alfonso, A., Palvadeau, Y., Delcros, C., Hawken, R., Alexander, L., Beattie, C., Schook, L., et al. (1998). Construction of a whole-genome radiation hybrid panel for high-resolution gene mapping in pigs. *Cytogenet Cell Genet.*, Vol.82, pp. 182-188.
- Yin, H., Litvinov, R.I., Vilaire, G., Zhu, H., Li, W., Caputo, G.A., Moore, D.T., Lear, J.D., Weisel, J.W., DeGrado, W.F. & Bennett, J.S. (2006). Activation of platelet alphaIIb beta3 by an exogenous peptide corresponding to the transmembrane domain of alphaIIb. *J. Mol. Chem.*, Vol.281, No.48, pp. 36732-36741.
- Yubero, N., Jiménez-Marín, Á., Barbancho, M., & Garrido, J.J. (2011). Two cDNAs coding for the porcine CD51 (α_v) integrin subunit: cloning, expression analysis, adhesion assays and chromosomal localization. *Gene*, Vol.481, pp. 29-40.